

Canon EF LENS

EF70-300mm f/4-5.6 IS II USM



IMAGE STABILIZER

 **ULTRASONIC**

ENG

Instructions

Thank you for purchasing a Canon product.

The Canon EF70-300mm f/4-5.6 IS II USM is a telephoto zoom lens, for use with EOS cameras.

- “IS” stands for Image Stabilizer.
- “USM” stands for Ultrasonic Motor.

Camera Firmware

Please use the latest version of firmware with the camera in use. For details on whether the firmware is the latest version or not, and for details on updating the firmware, please check the Canon website.

Conventions used in these instructions



Warning to prevent lens or camera malfunction or damage.



Supplementary notes on using the lens and taking pictures.

Safety Precautions

Precautions to ensure that the camera is used safely. Read these precautions thoroughly. Make sure all details are observed in order to prevent risks and injury to the user and other people.



Warning

Details pertaining to risks that may result in death or serious injury.

- **Do not look directly at the sun or other strong light sources through a lens.** This may result in loss of sight.
- **Do not leave a lens in the sun without the lens cap attached.** The lens may concentrate entering sunlight and cause a malfunction or fire.



Caution

Details pertaining to risks that may result in injury or damage to other objects.

- **Do not leave the product in places exposed to extremely high or low temperatures.** The product may cause burns or injury when touched.

General Precautions

Handling Precautions

- Do not leave the product in excessive heat such as in a car in direct sunlight. High temperatures can cause the product to malfunction.
- If the lens is taken from a cold environment into a warm one, condensation may develop on the lens surface and internal parts. To prevent condensation in this case, first put the lens into an airtight plastic bag before taking it from a cold to warm environment. Then take out the lens after it has warmed gradually. Do the same when taking the lens from a warm environment into a cold one.
- Please also read any lens related handling precautions listed in your camera's instruction manual.

Shooting Precautions

This lens uses Nano USM as the drive unit for the focus lens (the lens that aligns the focus). The motor also controls the focus lens during zooming.

1. When the camera is OFF

The motor does not operate while the camera is OFF or when the camera is OFF due to the use of the auto power off function. Therefore, users must be aware of the following points.

- Manual focus adjustments are not possible.
- During zooming, delayed focus will occur.

2. When the lens is in sleep mode

If not operated for a certain period of time, this lens will enter sleep mode in order to save power. Sleep mode differs from when the camera is OFF due to the use of the auto power off function.

In this state, the motor will not operate even if the camera is ON. Therefore, users must be aware of the following points.

- Manual focus adjustments are not possible.
- During zooming, delayed focus will occur.
- To exit sleep mode, press the shutter button halfway.

When using the lens with film single-lens reflex camera

- The drive speed of the focus lens will be slower than when the lens is used with a digital camera.
- Images will appear out of focus while the camera's internal flash is charging or when zooming during exposure for still images.
- Even when the camera in <ON>, images may appear out of focus when zooming. If this occurs, press the shutter button halfway while zooming.
- After focusing in AF mode or AF operation in the ONE SHOT AF mode and zooming by holding the shutter button halfway, the camera may indicate that the AF mode has been changed to manual focus (MF) mode.
- During continuous shooting, zooming may slow down shooting speed.
- There are some cases when users must wait a few seconds after zooming before the autofocus (AF) will function.
- When using the lens with film single-lens reflex camera other than the EOS-1V/HS, information may not be displayed on the lens information display (p.13-17) even when pressing the shutter button down halfway or all the way, or when pressing the display mode select button.
- When using the lens with certain film single-lens reflex cameras, displaying information on the lens information display may cause the autofocus (AF) to stop working. In this case, please shoot after first setting lens information display to OFF (p.13).
- When using the lens with certain film single-lens reflex cameras, operating the power switch between ON and OFF with the lens attached to the cameras may cause the autofocus (AF) and manual focus (MF) to stop working. In this case, please reattach the lens with the power switched <ON>.

This device complies with Part 15 of the FCC Rules.

Operation is subject to the following two conditions: (1) This device may not cause harmful interference, and (2) this device must accept any interference received, including interference that may cause undesired operation.

Do not make any changes or modifications to the equipment unless otherwise specified in the instructions. If such changes or modifications should be made, you could be required to stop operation of the equipment.

This equipment has been tested and found to comply with the limits for a class B digital device, pursuant to part 15 of the FCC Rules. These limits are designed to provide reasonable protection against harmful interference in a residential installation. This equipment generates, uses and can radiate radio frequency energy and, if not installed and used in accordance with the instructions, may cause harmful interference to radio communications.

However, there is no guarantee that interference will not occur in a particular installation. If this equipment does cause harmful interference to radio or television reception, which can be determined by turning the equipment off and on, the user is encouraged to try to correct the interference by one or more of the following measures:

- Reorient or relocate the receiving antenna.
- Increase the separation between the equipment and receiver.
- Connect the equipment into an outlet on a circuit different from that to which the receiver is connected.
- Consult the dealer or an experienced radio/TV technician for help.

Nomenclature

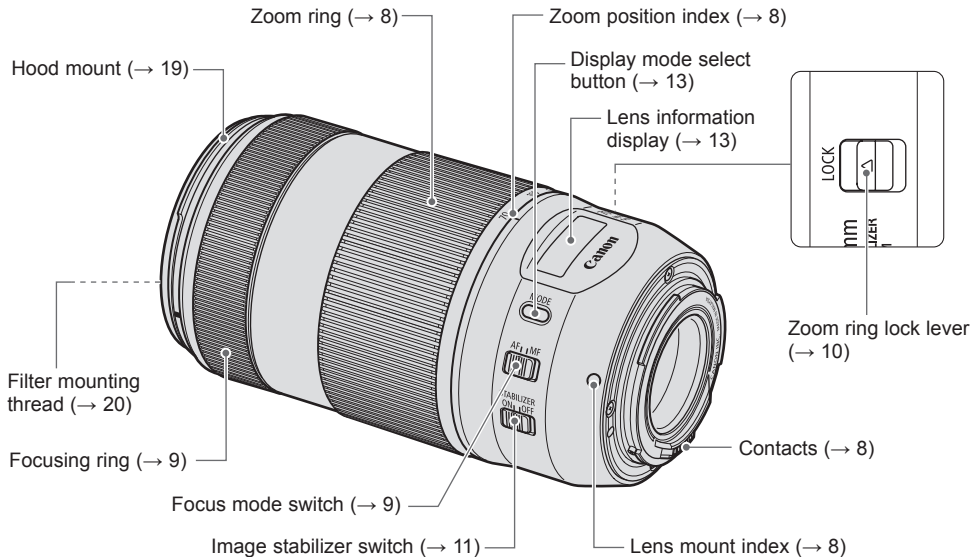

● For detailed information, reference page numbers are provided in parentheses (→ **).

1. Mounting and Detaching the Lens

See your camera's instructions for details on mounting and detaching the lens.

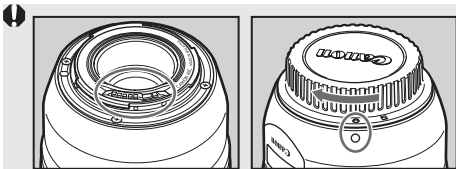

- After detaching the lens, place the lens with the rear end up to prevent the lens surface and contacts from getting scratched.
- If the contacts get soiled, scratched, or have fingerprints on them, corrosion or faulty connections can result. The camera and lens may not operate properly.
- If the contacts get soiled or have fingerprints on them, clean them with a soft cloth.
- Attach the lens cap and dust cap when disconnecting the lens. When attaching the dust cap, align the lens mount index with the ○ index of the dust cap and rotate in a clockwise direction as shown in the illustration. Follow the reverse procedure to detach it.

2. Zooming

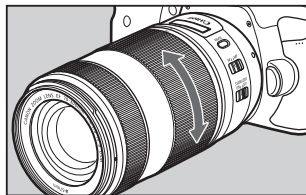

To zoom, turn the lens' zoom ring.

- Be sure to finish zooming before focusing. Zooming after focusing can affect the focus.
- Blurring may temporarily occur if the zoom ring is quickly rotated.
- Zooming when the camera is OFF will result in delayed focus.
- Zooming during still image exposure will result in delayed focus. This causes any streaks of light that are captured during exposure to be blurred.

3. Setting the Focus Mode

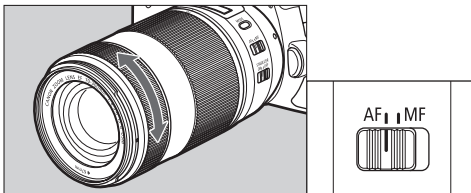

 After autofocusing in the AF mode or AF operation in the ONE SHOT AF mode, focus manually by pressing the shutter button halfway and turning the focusing ring (Full-time manual focus).

To shoot in autofocus (AF) mode, set the focus mode switch to AF.

To use only manual focusing (MF), set the focus mode switch to MF, and focus by turning the focusing ring.

-  ● Quickly rotating the focusing ring may result in delayed focus.
- Manual focus adjustments are not possible when the camera is OFF.

4. Fixing the Zoom Ring

The zoom ring can be fixed to keep the lens at the shortest point. This function is convenient for carrying a camera on a strap because it prevents the lens from extending.

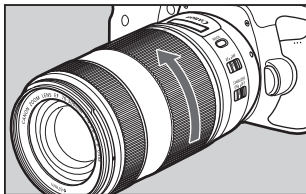
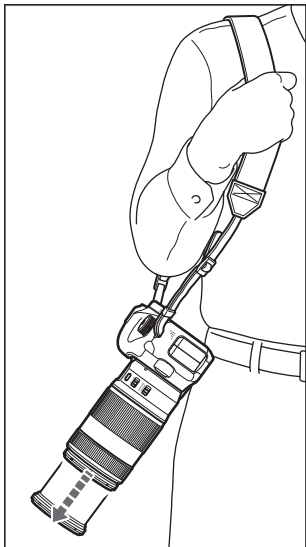

1 Rotate the zoom ring to the widest position (70 mm).

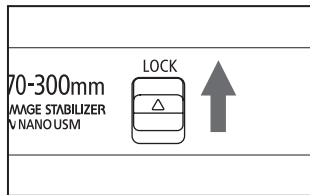

2 Slide the zoom ring lock lever in the direction indicated by the arrow.

- To release the zoom ring, slide the zoom ring lock lever in the direction opposite to the arrow.

! The zoom ring cannot be fixed in place at any position other than the widest position.

5. Image Stabilizer

You can use the image stabilizer in AF or MF mode.

This function provides optimal image stabilization depending on shooting conditions (such as shooting still subjects and following shots).

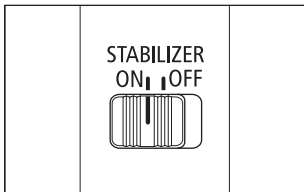

1 Set the **STABILIZER** switch to **<ON>**.

- If you are not going to use the image stabilizer function, set the switch to **<OFF>**.

2 When you press the shutter button halfway, the **Image Stabilizer** will start operating.

- Make sure the image in the viewfinder is stable, then press the shutter button the rest of the way down to take the picture.



<ON>



<OFF>

The image stabilizer in this lens is effective for hand-held shots under the following conditions.

- In semi-darkened areas such as indoors or outdoors at night.
- In locations where flash photography is prohibited, such as art museums and theater stages.
- In situations where your footing is uncertain.
- When panning subjects in motion.
- In situations where fast shutter settings cannot be used.

Image Stabilizer



- The Image Stabilizer cannot compensate for a blurred shot caused by a subject that moved.
- Set the STABILIZER switch to <OFF> when you are taking pictures using the Bulb setting (long exposures). If the STABILIZER switch is set to <ON>, the image stabilizer function may introduce errors.
- The Image Stabilizer may not be fully effective if you shoot from a violently shaking vehicle or other transportation.
- The Image Stabilizer consumes more power than normal shooting, resulting in fewer shots and a shorter movie shooting time.
- The image stabilizer operates for about two seconds even when your finger is off the shutter button. Do not remove the lens while the stabilizer is in operation. This will cause a malfunction.
- With the EOS-1V/HS, 3, ELAN 7E/ELAN 7/30/33, ELAN 7NE/ELAN 7N/30V/33V, ELAN II/ELAN II E/50/50E, REBEL 2000/300, IX, IX Lite/IX7, and D30, the Image Stabilizer will not work during self-timer operation.



- Using a tripod also stabilizes the image. However, depending on the kind of tripod and shooting conditions, sometimes it may be better to turn off the Image Stabilizer function.
- Even with a monopod, the Image Stabilizer will be as effective as during hand-held shooting. However, depending on the shooting conditions, there are cases in which the Image Stabilizer effect may be less effective.
- The image stabilizer function also operates when the lens is used with an Extension Tube EF12 II or EF25 II.
- Depending on the camera there may be image shake, such as after releasing the shutter. However, this does not affect shooting.
- If you set the camera's Custom Function to change the assigned button to operate the AF, the Image Stabilizer will operate when you press the newly assigned AF button.

6. Lens Information Display

The lens information display allows the user to select either “Focus distance,” “Focal length indicator,” or “Shake amount” for the display setting when the camera is turned <ON>.

(1) Focusing distance display mode



(2) Focal length display mode



(3) Camera shake amount display mode



■ Lens information display control

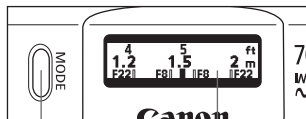

Display mode select button

Lens information display

Holding down the display mode select button (more than 2 seconds) will switch the lens information display from ON to OFF or from OFF to ON.

If the lens information display is set to OFF, no information will be displayed on the lens information display even if the camera and lens are operating.

- When the lens information display is ON, more battery power is used compared to when it is OFF which results in a lower number of images which can be taken and a decrease in the amount of time for movie shooting.
- It is not possible to adjust the backlight or display density of the lens information display.

Lens Information Display

■ Display mode selection

You can switch from one display mode to another when the display is ON by pressing the display mode select button for a short duration (less than 1 second).

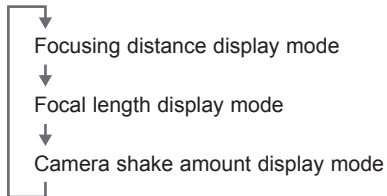

- The last display mode setting is remembered even when the camera is turned <OFF>.
- A black-white reversed display is obtained by pressing the display mode select button between 1 and 2 seconds.



■ Display modes

(1) Focusing distance display mode



This mode is used to display the lens's focusing distance. The depth-of-field scale appears at the bottom of the display (see "8. Depth-of-Field Scale" on p. 18).

(2) Focal length display mode



This mode is used to display the lens's focal length. When the lens is used with an APS-H or APS-C format camera, a 35 mm equivalent focal length image is displayed by the camera (see "Additional Information" on p. 21).

When a 35 mm equivalent focal length image is displayed by the camera, "35mm EQV" is displayed in the lower left of the lens information display.

Lens Information Display

- The focusing distance display and focal length display are only to serve as guides.
- When using the lens with a 35 mm full-format camera and there is a difference between the information displayed on the lens information screen and the zoom ring indication, please follow the zoom ring indication.
- 35 mm format conversion is not possible in the following cases:
 - When using the lens with either a EOS 5DS or 5DS R camera which is set to 1.3x or 1.6x crop shooting.
 - When using the lens with any of the following cameras: EOS D6000, EOS D2000, EOS DCS 1, and EOS DCS 3
 - When focal length information is recorded in image data (Exif data)

(3) Camera shake amount display mode



This mode is used to display the amount of vertical and horizontal shake the camera and lens are experiencing.

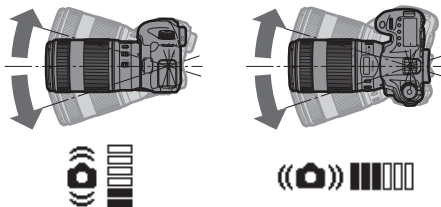

- The camera shake amount display is to only serve as a guide. Even if no shake is indicated, it does not guarantee that images will be in focus.
- The camera shake amount display uses information from the sensor which activates the Image Stabilizer. However, it does not indicate the effectiveness of the Image Stabilizer.
- Since the lens information display is located on the lens, it is not possible to view the camera shake amount information while using the camera's viewfinder or LCD monitor. Therefore, please use it as a guide to check how to hold the camera and how to press the shutter button in order to reduce camera shake.

Lens Information Display

■ Information display method according to camera type

When the lens information display is set to display information (p. 13), display conditions differ according to the type of camera (1 to 4 below) used.

1. When the lens is used with either a film single-lens reflex camera or digital single-lens reflex camera, the following operations will be indicated on the lens information display for a period of approximately 10 seconds.
 - Shutter button is pressed halfway/all the way
 - Display mode select button is pressed (when pressed for under 2 seconds)



- When the following operations are performed while related operation information is being displayed, they will be indicated for an additional period of approximately 10 seconds beginning from when such operation was initiated.
 - Shutter button is pressed halfway/all the way
 - Display mode select button is pressed (when pressed for under 2 seconds)
 - Manual focus operation
 - Zooming
 - Switching from Live View shooting to still-image shooting
 - Switching from movie shooting to still-image shooting

2. When the lens is used with a digital single-lens reflex camera, the display is switched to continuous display when the following operations are performed.
 - When switching to Live View shooting
 - When switching to movie shooting
 - When set to movie shooting before turning the camera <ON>.
3. When the lens is used with mirrorless cameras (EOS R series cameras)*, the display is switched to continuous display when the power to the camera is switched <ON>.
* Mount Adapter EF-EOS R required.



To stop continuous display, press the display mode select button for more than 2 seconds.

Lens Information Display

4. When the lens is used with a mirrorless camera (EOS M series cameras)*, information is displayed as indicated by the two camera model based categories below.

* Mount Adapter EF-EOS M required.

4-1: EOS M2, M

Information is continuously displayed for the following operations when the camera is turned <ON>.

- Shutter button is pressed halfway/all the way
- Display mode select button is pressed (when pressed for under 2 seconds)

4-2: Other models in the EOS M series

Information is continuously displayed when the camera is turned <ON>.



To stop continuous display, press the display mode select button for more than 2 seconds.



- Depending on the camera used, information may not be displayed even when pressing the display mode select button when the camera is OFF as a result of being set to Auto Power OFF. To turn the camera ON again, press the shutter button halfway.
- When using the lens with film single-lens reflex cameras other than the EOS-1V/HS, information may not be displayed even when pressing the shutter button down halfway or all the way, or when pressing the display mode select button.
- When using the lens with the EOS-1D Mark III or EOS-1Ds Mark III, information will not be displayed even when switching to Live View shooting mode.
- Depending on the camera used, information may disappear from the display even before 10 seconds has been reached since the information was initially displayed.
- Depending on the camera used, information may not be displayed for a full additional 10 seconds after an operation is performed while related information is displayed.
- Depending on the camera used, using the camera's dials, menu buttons, etc. may cause information to disappear from the display, prevent information from being displayed for a full 10 seconds, or cause information to be displayed continuously for more than 10 seconds.
- Although this does apply to some cameras, information will not be displayed when the camera is set to Bulb (long exposure) mode even if the shutter button is pressed halfway/all the way.
- When shooting a time-lapse movie, information will randomly appear and disappear from the display.

7. Infinity Compensation Mark

See “6. Lens Information Display” and switch the display mode to “Focusing distance display mode.”

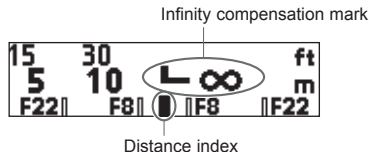

To compensate for shifting of the infinity focus point that results from changes in temperature, there is a margin at the infinity (∞) position. The infinity position at normal temperature is the point at which the vertical line of the distance scale L mark is aligned with the distance index.

! For accurate manual focusing of subjects at infinity, look through the viewfinder or look at the magnified image* on the LCD screen while rotating the focusing ring.

* When using the lens with cameras capable of Live View shooting, the infinity position can be checked by magnifying the image.

8. Depth-of-Field Scale

See “6. Lens Information Display” and switch the display mode to “Focusing distance display mode.”

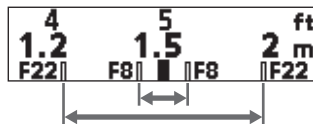

The depth of field is the distance in front of and behind the plane of focus on the subject that appears sharp. The depth of field is indicated by the area between the depth-of-field scale lines below the distance scale. The numbers on the scale are F values.

- !** The depth-of-field scale position changes due to zooming. For f/8, when the display space becomes narrow the display disappears and only the scale which shows f/8 is displayed. When moving closer to the telephoto end (300 mm), the scale which shows f/8 also disappears.
- The depth-of-field scale is only to serve as a guide.

9. Hood (sold separately)

The ET-74B hood cuts out unwanted light and protects the front of the lens from rain, snow, and dust.

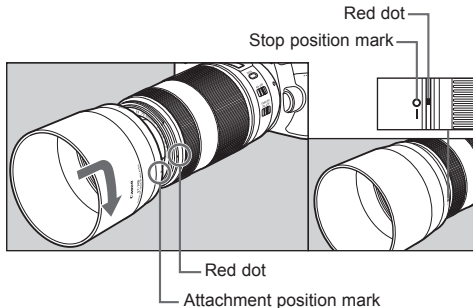

● Attaching

Align the red attachment position mark on the hood with the red dot on the front of the lens, and then rotate the hood in the direction of the arrow until it is firmly attached with the red dot and stop position mark on the hood aligned.

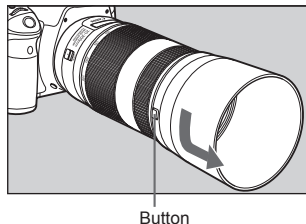

● Removing

Keep your finger pressed down on the button located on the side of the hood, and then rotate the hood in the direction of the arrow until the attachment position mark on the hood is aligned with the red dot on the front of the lens to detach it. The hood can be reverse-mounted on the lens for storage.



- If the hood is not attached properly, vignetting (darkening of the perimeter of the picture) may occur.
- Grasp and rotate the base of the hood when attaching and detaching it. There are cases in which it may become deformed if the hood is rotated with it grasped near to the rim.

10. Filters (sold separately)

You can attach filters to the filter mounting thread on the front of the lens.

- Only one filter may be attached.
- If you need a polarizing filter, use the Canon Circular Polarizing Filter PL-C B (67 mm).
- Detach the hood when adjusting the polarizing filter.

11. Extension Tubes (sold separately)

You can attach extension tube EF12 II or EF25 II for magnified shots. The shooting distance and magnification are shown below.

		Focusing Distance Range (mm)		Magnification (×)	
		Close distance	Long distance	Close distance	Long distance
EF12 II	70mm	468	623	0.25	0.17
	300mm	1055	7645	0.32	0.04
EF25 II	70mm	355	406	0.47	0.38
	300mm	953	3908	0.40	0.09



MF mode is recommended for accurate focusing.

Additional Information

■ 35 mm equivalent focal length image

When the lens is used with an APS-H or APS-C format camera, images are displayed at 1.3x or 1.6x respectively. For example, when the lens is used with an APS-H format camera, an image with a focal length of 70 mm appears as if its focal length is 91 mm, and an image with a focal length of 300 mm appears as if its focal length is 390 mm. When the lens is used with an APS-C format camera, an image with a focal length of 70 mm appears as if its focal length is 112 mm, and an image with a focal length of 300 mm appears as if its focal length is 480 mm. At the same time, “35mm EQV” is displayed in the lower left of the lens information display.

Specifications

Focal Length/Aperture	70-300mm f/4-5.6
Lens Construction	12 groups, 17 elements
Minimum Aperture	f/32-45
Angle of View	Diagonal: 34° - 8°15', Vertical: 19°30' - 4 °35', Horizontal: 29° - 6°50'
Min. Focusing Distance	1.2 m/3.94 ft.
Max. Magnification	0.25x (at 300 mm)
Field of View	Approx. 365 x 554 - 97 x 144 mm/14.37 x 21.81 - 3.82 x 5.67 inch (at 1.2 m/3.94 ft.)
Filter Diameter	67 mm
Max. Diameter and Length	Approx. 80 x 145.5 mm/3.15 x 5.73 inch
Weight	Approx. 710 g/25.0 oz.
Hood	ET-74B (sold separately)
Lens Cap	E-67 II
Case	LP1222 (sold separately)

- The lens length is measured from the mount surface to the front end of the lens. Add 24.2 mm when including the lens cap and dust cap.
- The size and weight listed are for the lens only, except as indicated.
- Extenders cannot be used with this lens. In addition, there are no close-up lenses designed for use with this lens.
- Aperture settings are specified on the camera. The camera automatically compensates for variations in the aperture setting when the camera is zoomed in or out.
- All data listed is measured according to Canon standards.
- Product specifications and appearance are subject to change without notice.

Only for European Union and EEA (Norway, Iceland and Liechtenstein)



This symbol indicates that this product is not to be disposed of with your household waste, according to the WEEE Directive (2012/19/EU) and national legislation. This product should be handed over to a designated collection point, e.g., on an authorized one-for-one basis when you buy a new similar product or to an authorized collection site for recycling waste electrical and electronic equipment (EEE). Improper handling of this type of waste could have a possible negative impact on the environment and human health due to potentially hazardous substances that are generally associated with EEE. At the same time, your

cooperation in the correct disposal of this product will contribute to the effective usage of natural resources. For more information about where you can drop off your waste equipment for recycling, please contact your local city office, waste authority, approved WEEE scheme or your household waste disposal service. For more information regarding return and recycling of WEEE products, please visit www.canon-europe.com/weee.

Canon