

\* podle modelu - v závislosti od modelu - modelltól függően - sõltuvalt mudelist - atkarībā no modeļa - priklausomai nuo modelio - според модела - în funcție de model - u zavisnosti od modela - ovisno o modelu - ovisno o modelu - odvisno od modela - үлгіге байланысты - в зависимости от модели - залежно від моделі - แตกต่างกันไปในแต่ละรุ่น - je nach Modell - Secondo il modello

1

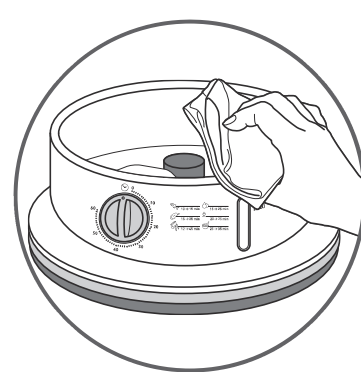

2a

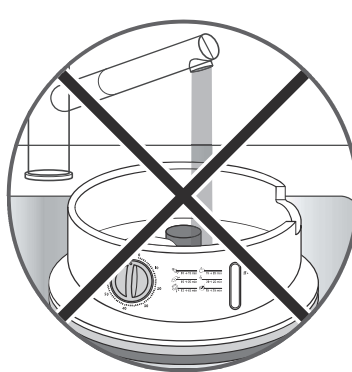
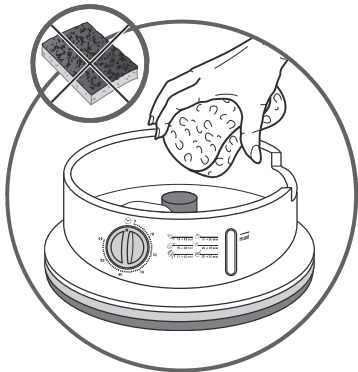
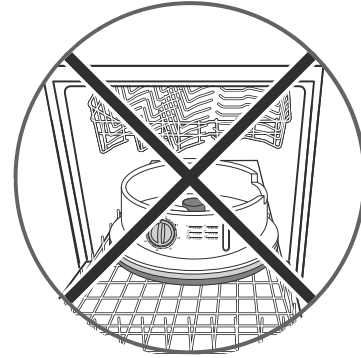
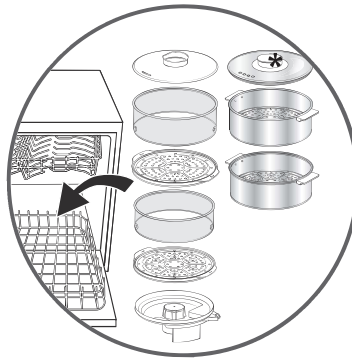
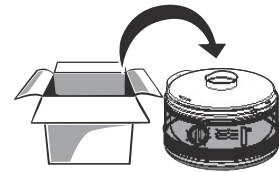
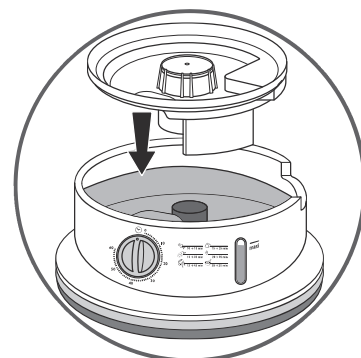
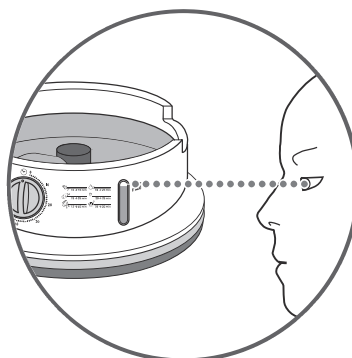
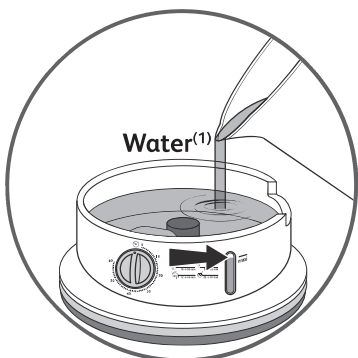
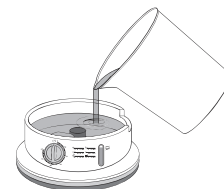

\* podle modelu - v závislosti od modelu - modelltöl fúggóen - sóltuvalt mudelist - atkaribā no modeļa - priklausomai nuo modelio - според модела - în funcție de model - u zavisnosti od modela - ovisno o modelu - ovisno o modelu - odvisno od modela - үлгіре байланысты - в зависимости от модели - залежно від моделі - แตกต่างกันไปในแต่ละรุ่น - je nach Modell - Secondo il modello

(1) Voda - Voda - Víz - Vesi - Üdens - Vanduo - Вода - Apā - Voda - Voda - Voda - Voda - Cy - вода - Вода - น้ำ - Wasser - Acqua

2b

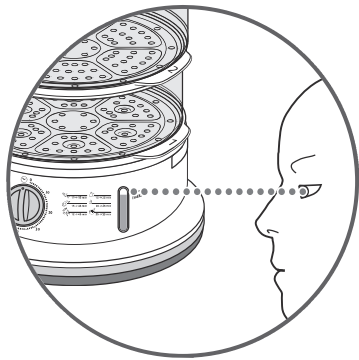
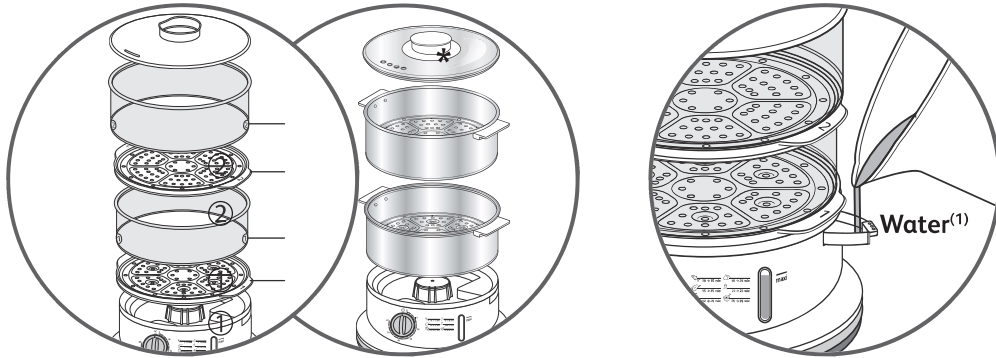
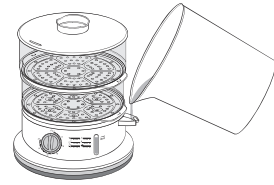

3a

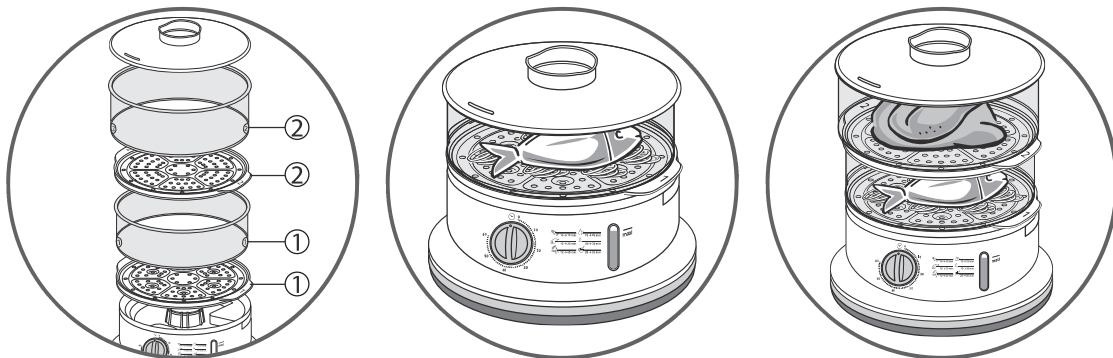
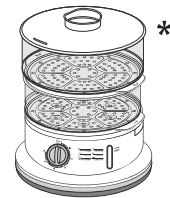

\* podle modelu - v závislosti od modelu - modelltöl fúggöen - söltuvalt mudelist - atkaribā no modeļa - priklausomai nuo modelio - според модела - în funcție de model - u zavisnosti od modela - ovisno o modelu - ovisno o modelu - odvisno od modela - үлгіре байланысты - в зависимости от модели - залежно від моделі - แตกต่างกันไปในแต่ละรุ่น - je nach Modell - Secondo il modello

4

(1) Voda - Voda - Víz - Vesi - Üdens - Vanduo - Вода - Apă - Voda - Voda - Voda - Voda - Cy - вода - Вода - น้ำ - Wasser - Acqua



3a

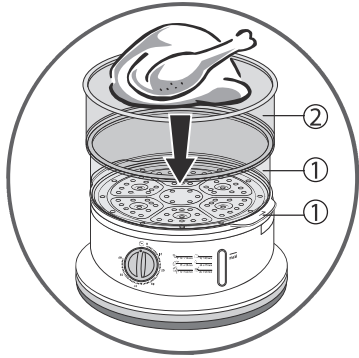
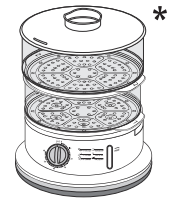

3b

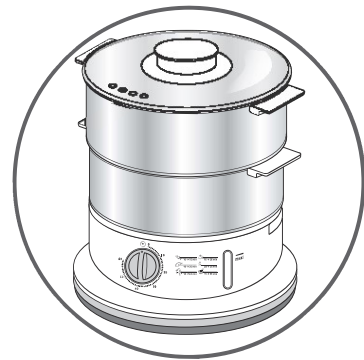
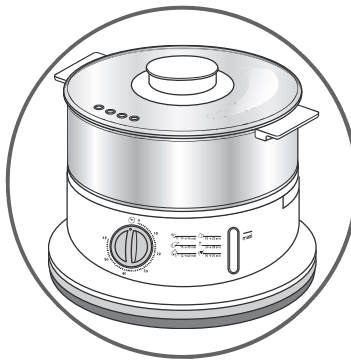
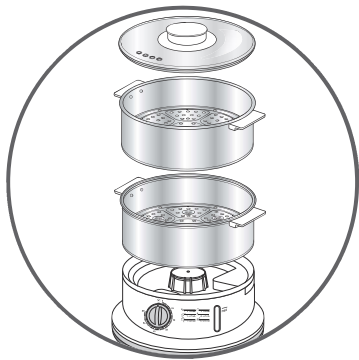
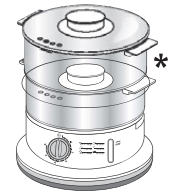

\* podle modelu - v závislosti od modelu - modelltöl fúggöen - söltuvalt mudelist - atkaribā no modeļa - priklausomai nuo modelio - според модела - în funcție de model - u zavisnosti od modela - ovisno o modelu - ovisno o modelu - odvisno od modela - үлгіре байланысты - в зависимости от модели - залежно від моделі - แตกต่างกันไปในแต่ละรุ่น - je nach Modell - Secondo il modello

4

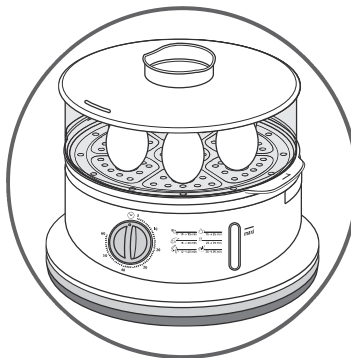
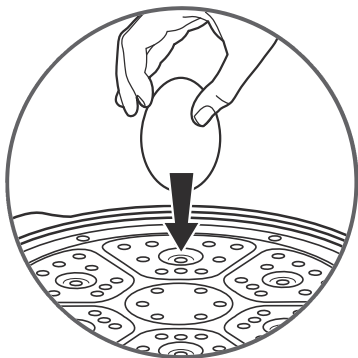
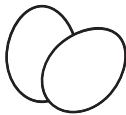
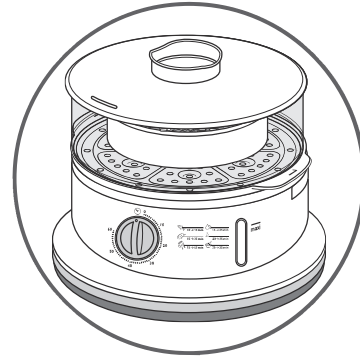
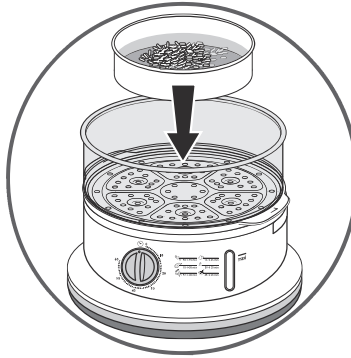
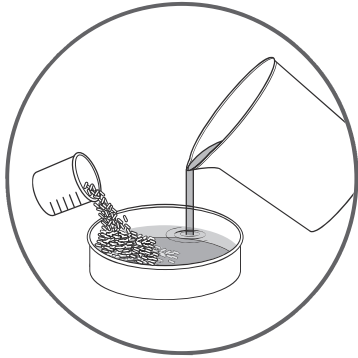
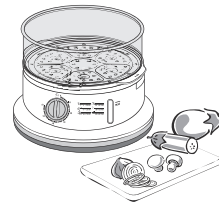

5

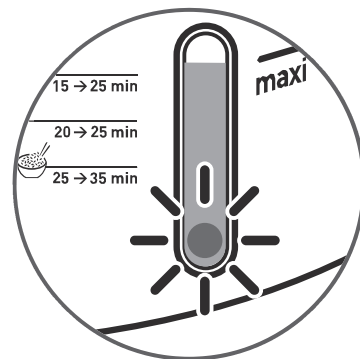
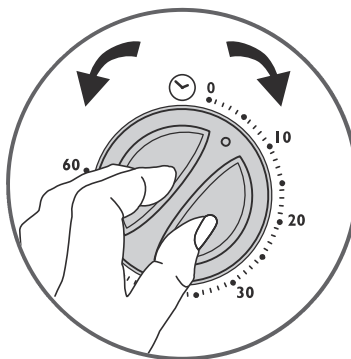
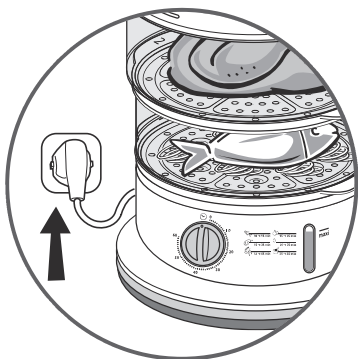

6

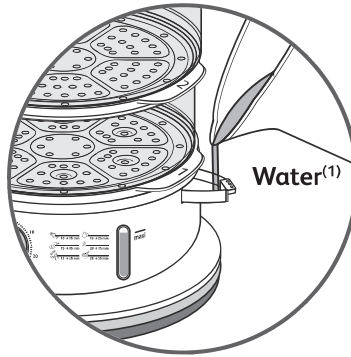
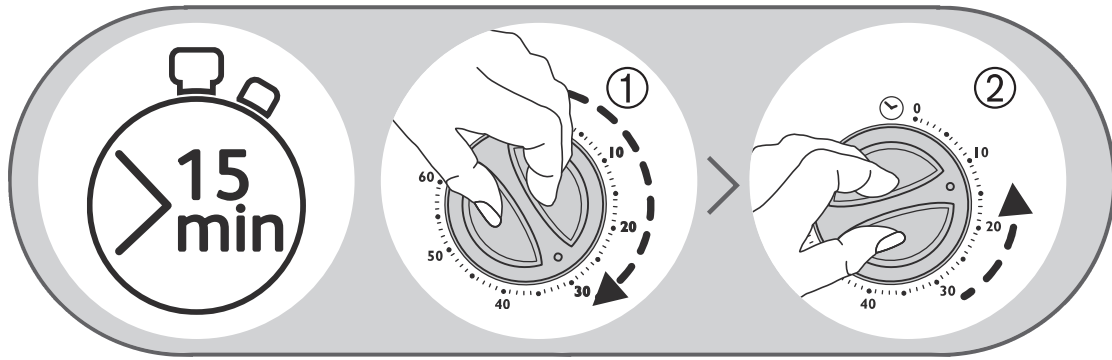

(1) Voda - Voda - Víz - Vesi - Ūdens - Vanduo - Вода - Apă - Voda - Voda - Voda - Voda - Су - вода - Вода - น้ำ - Wasser - Acqua

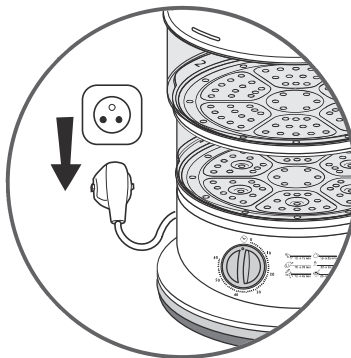
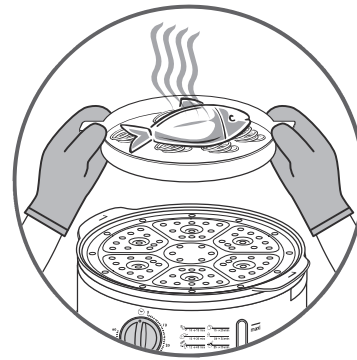
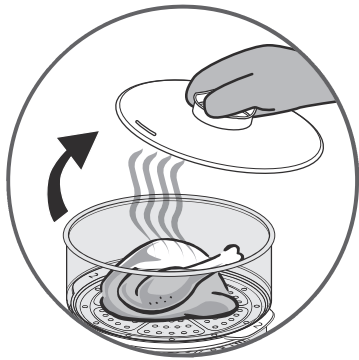
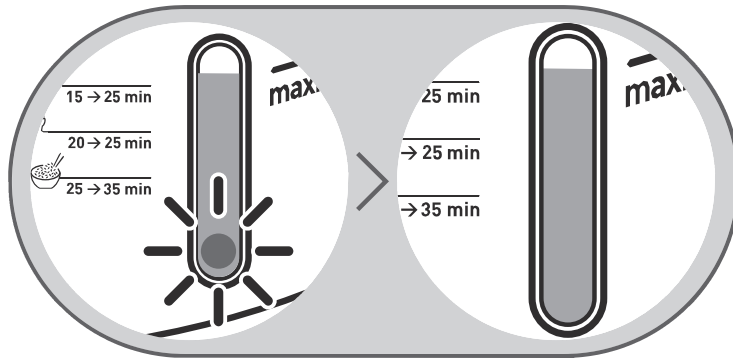
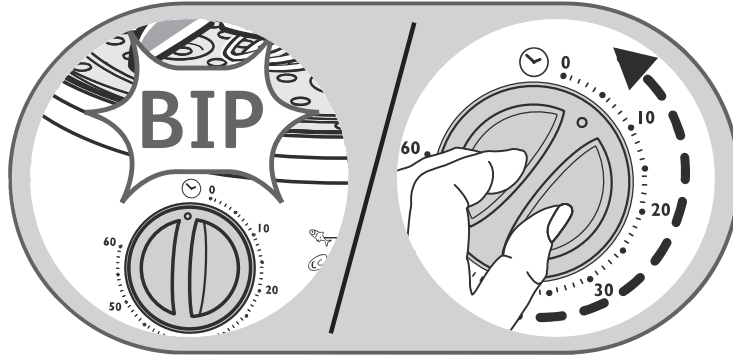

7

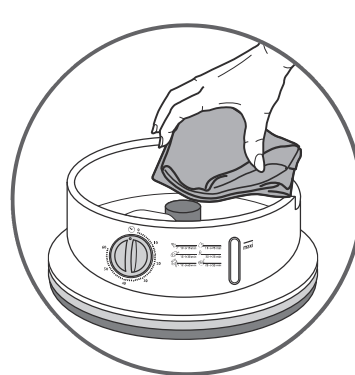
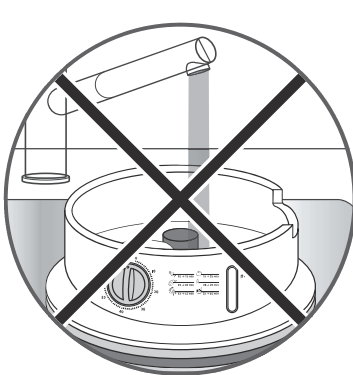
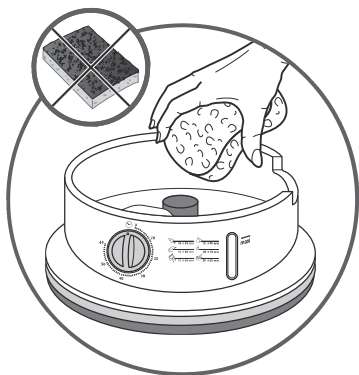
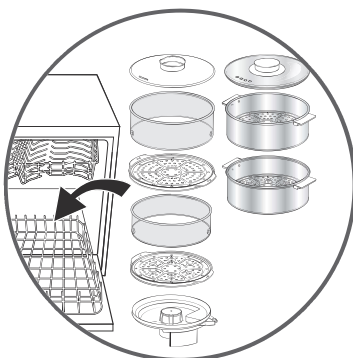
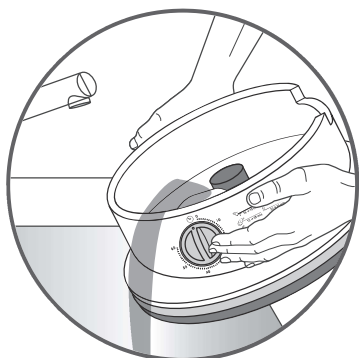
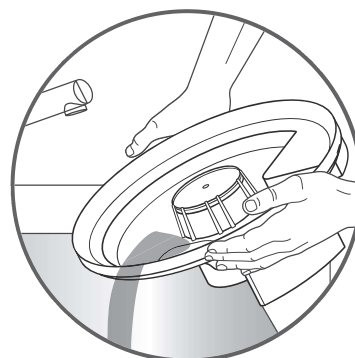
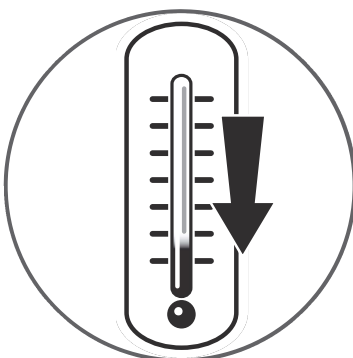
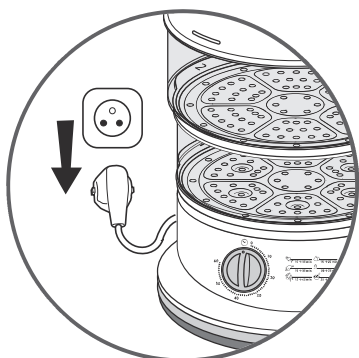
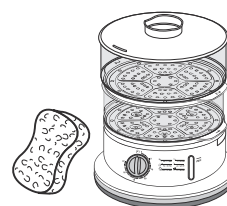

\* podle modelu - v závislosti od modelu - modelltöl fúggöen - sóltuvalt mudelist - atkaribā no modeļa - priklausomai nuo modelio - според модела - în funcție de model - u zavisnosti od modela - ovisno o modelu - ovisno o modelu - odvisno od modela - үлгіге байланысты - в зависимости от модели - залежно від моделі - แตกต่างกันไปในแต่ละรุ่น - je nach Modell - Secondo il modello

7

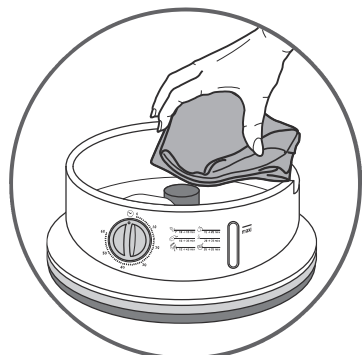
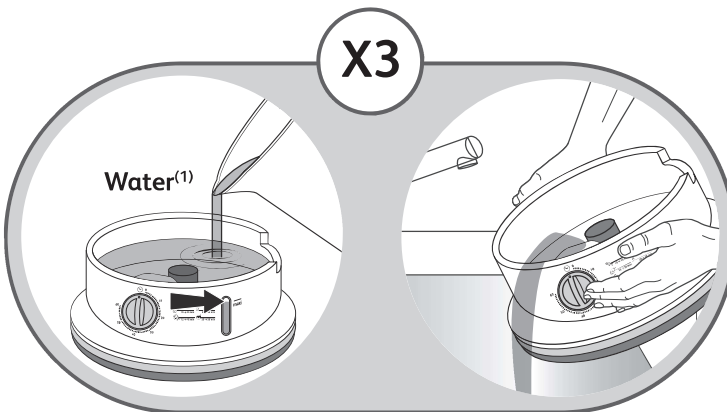
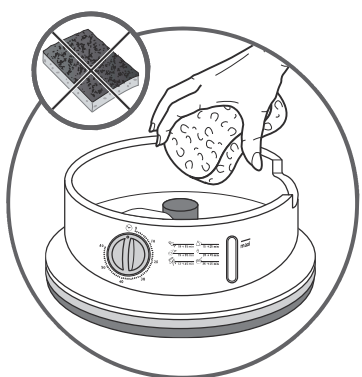
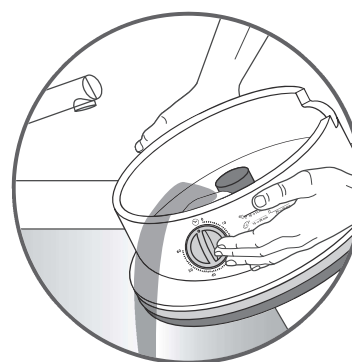
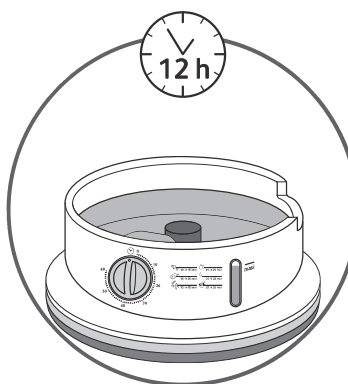
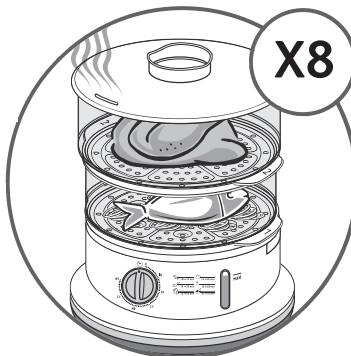
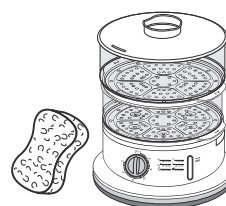

(1) Voda - Voda - Víz - Vesi - Ūdens - Vanduo - Вода - Apā - Voda - Voda - Voda - Voda - Cy - вода - Вода - น้ำ - Wasser - Acqua  
 (2) Bílý ocet - Biely ocot - Fehérecet - Valge äädikas - Baltais etiķis - Baltasis actas - Бял оцет - Oțet alb - Belo sirće - Bijelo sirće - Bijeli ocat - Alkoholni kis - Ақ сірке су - белый уксус - Білий оцет - น้ำส้มสายชู - weißem Essig - Aceto bianco





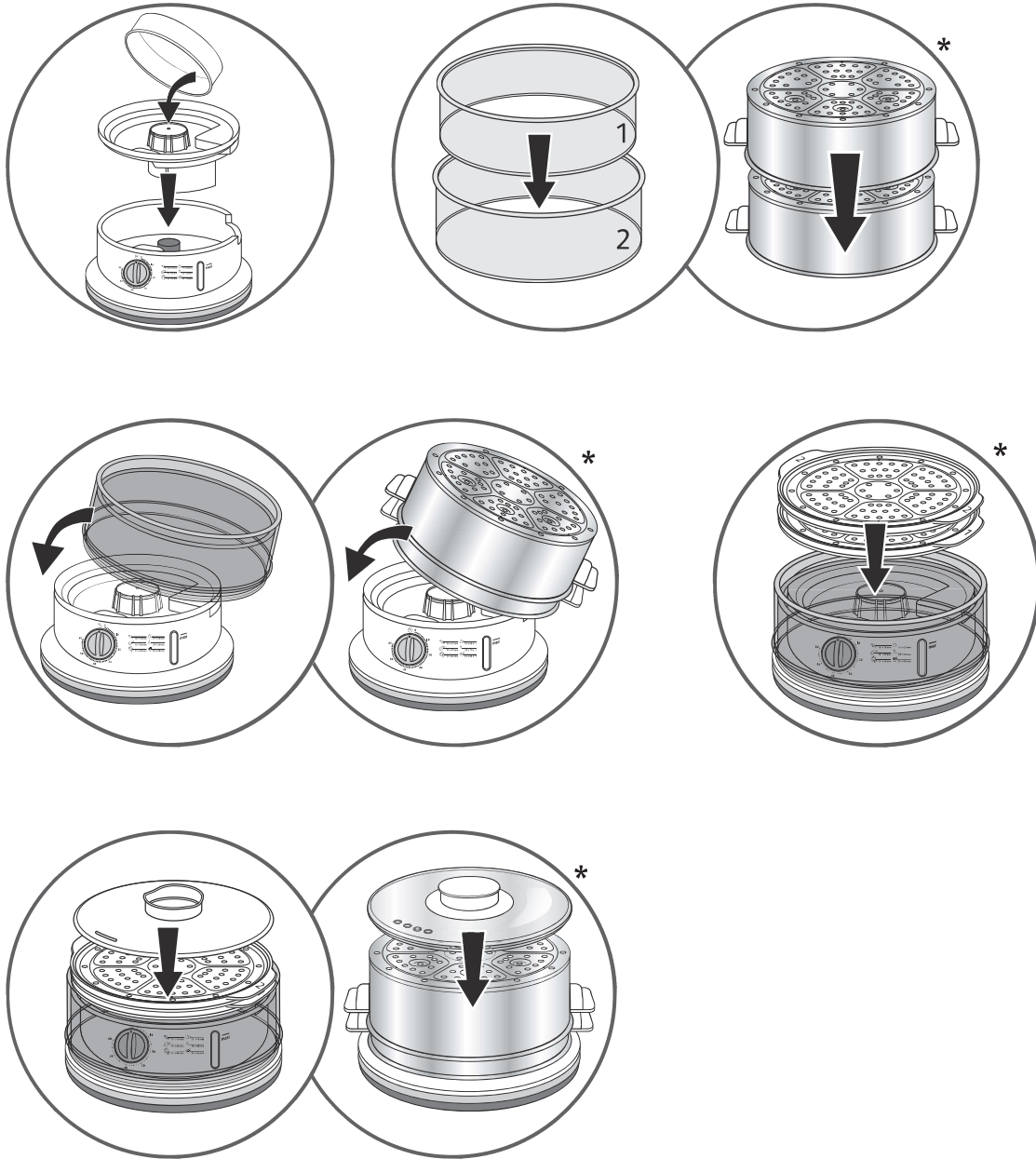
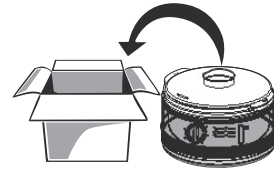



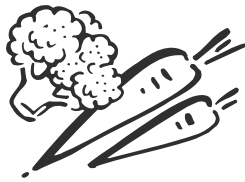
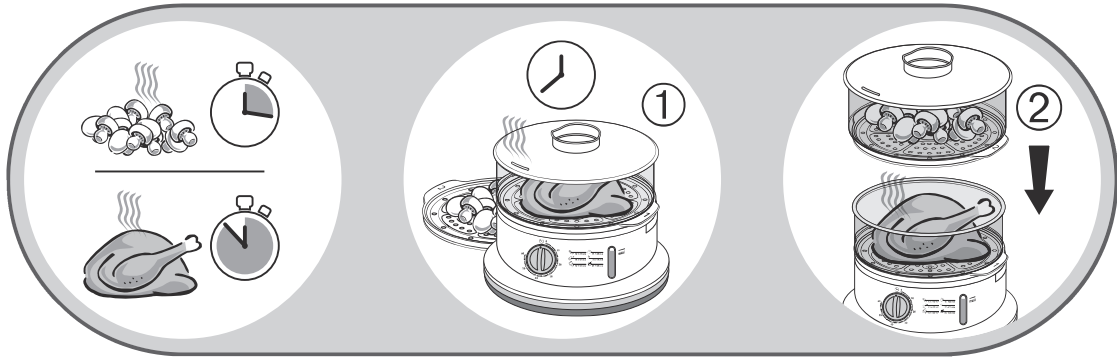





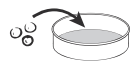

















8



\* podle modelu - v závislosti od modelu - modelltöl fúggöen - sòltuvalt mudelist - atkaribā no modeļa - priklausomai nuo modelio - според модела - în funcție de model - u zavisnosti od modela - ovisno o modelu - ovisno o modelu - odvisno od modela - үлгіре байланысты - в зависимости от модели - залежно від моделі - แตกต่างกันไปในแต่ละรุ่น - je nach Modell - Secondo il modello



			 (i) 
		550 g	30-35 min
		500 g	30-35 min
	***	400 g	25-31 min
		300 g	20-25 min
		500 g	20-25 min
		600 g	25-30 min
			30-35 min
		300 g	15-20 min
	***	300 g	15-20 min
		450 g	35-40 min
	***	400 g	30-35 min



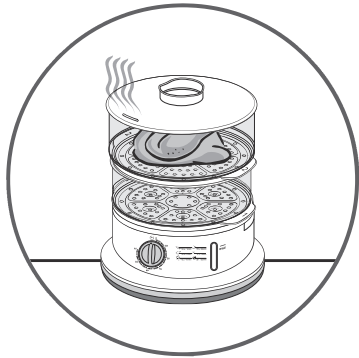
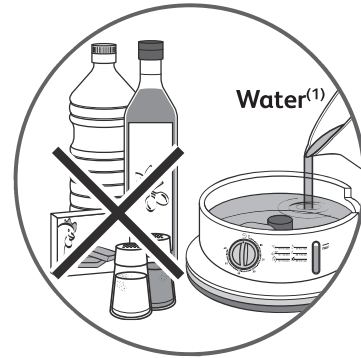
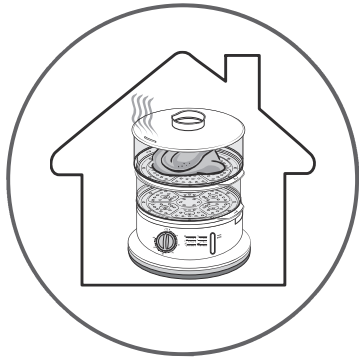

			300 g	  (i) 	50-55 min
			300 g		50-55 min
			600 g		40-45 min
			600 g		30-35 min
			4	  (i) 	30-35 min
			4		15-20 min
			350 g	  (i) 	10-15 min
			400 g		15-20 min
			300 g		15-20 min
			450 g		20-25 min
			4		35-40 min
			6		20-25 min
		200 mL Water <sup>(1)</sup>	125 g		30-35 min

<sup>(1)</sup> Voda - Voda - Víz - Vesi - Üdens - Vanduo - Вода - Apă - Voda - Voda - Voda - Voda - Cy - вода - Вода - น้ำ - Wasser - Acqua

10 \_\_\_\_\_





<sup>(1)</sup> Voda - Voda - Víz - Vesi - Ūdens - Vanduo - Вода - Apă - Voda - Voda - Voda - Voda - Су - вода - Вода  
- น้ำ - Wasser - Acqua





<b>INTERNATIONAL GUARANTEE COUNTRY LIST</b>			
<b>SMALL HOUSEHOLD APPLIANCES</b>			
			
<b>ARGENTINA</b>	0800-122-2732	2 años 2 years	GRUPE SEB ARGENTINA S.A. Billinghurst 1833 3° C1425DTK Capital Federal Buenos Aires
<b>ՀԱՅԱՍՏԱՆ ARMENIA</b>	010 55-76-07	2 տարի 2 years	«SEB Ուկրաինիա խումբ» ընկերություն Խարկովի խճուղի, 201-203, 3-րդ հարկ Գիելվ, 02121 Ուկրաինա 2 տարի
<b>AUSTRALIA</b>	1300307824	1 year	Groupe SEB Australia PO Box 404 North Ryde, NSW, 1670
<b>ÖSTERREICH AUSTRIA</b>	01 890 3476	2 Jahre 2 years	GRUPE SEB DEUTSCHLAND GmbH Theodor-Stern-Kai 1 60596 Frankfurt
<b>البحرين BAHRAIN</b>	17716666	1 year	www.tefal-me.com
<b>БЕЛАРУСЬ BELARUS</b>	017 2239290	2 года 2 years	ЗАО «Группа СЕБ-Восток», Москва, 125171, Ленинградское шоссе, д.16А, строение 3, помещение XII
<b>BELGIQUE BELGIE BELGIUM</b>	070 23 31 59	2 ans 2 jaar 2 years	GRUPE SEB BELGIUM SA NV 25 avenue de l'Espérance - ZI 6220 Fleurus
<b>BOSNA I HERCEGOVINA</b>	Info-linija za potrošače 033 551 220	2 godine 2 years	SEB Developpement Predstavništvo u BiH Valtera Perića 6/I 71000 Sarajevo
<b>BRASIL BRAZIL</b>	11 2915-4400	1 ano 1 year	Seb Comercial gAv Jornalista Roberto Marinho, 85, 19º andar 04576 – 010 São Paulo - SP
<b>БЪЛГАРИЯ BULGARIA</b>	0700 10 330	2 години 2 years	Груп Себ България ЕООД бул. България 58 С, ет 9, офис 30 1680 София
<b>CANADA</b>	1-800-418-3325	1 an 1 year	Groupe SEB Canada Inc. 36 Newmill Gate, Unit 2 Scarborough, ON M1V 0E2
<b>CHILE</b>	02 2 884 46 06	2 años 2 years	GRUPE SEB CHILE Comercial Ltda Avenida Santa María 0858, Providencia - Santiago
<b>COLOMBIA</b>	018000520022	2 años 2 years	GRUPE SEB COLOMBIA Apartado Aereo 172, Kilometro 1 Via Zipaquira Cajica Cundinamarca
<b>HRVATSKA CROATIA</b>	01 30 15 294	2 godine 2 years	SEB mku & p d.o.o. Sarajevska 29, 10000 Zagreb

			
<b>ČESKÁ REPUBLIKA CZECH REPUBLIC</b>	731 010 111	2 roky 2 years	Groupe SEB ČR s.r.o. Futurama Business Park (budova A) Sokolovská 651/136a 186 00 Praha 8
<b>DANMARK DENMARK</b>	44 66 31 55	2 år 2 years	GRUPE SEB NORDIC AS Tempovej 27 2750 Ballerup
<b>مصر EGYPT</b>	16622	سنة واحدة 1year	جروب سب إيجيبت القاهرة: ١٢١ شارع الحجاز، مصر الجديدة الإسكندرية: طريق أمابو، سموحة
<b>EESTI ESTONIA</b>	668 1286	2 aastat 2 years	Groupe SEB Polska Sp. z o.o. Gdański Business Center II D ul. Inflancka 4C 00-189 Warsaw
<b>SUOMI FINLAND</b>	09 8946 150	2 vuotta 2 years	Groupe SEB Finland OY Pakkalankuja 6 01510 Vantaa
<b>FRANCE Continentale + Guadeloupe, Martinique, Réunion, St-Martin</b>	09 74 50 47 74	2 ans 2 years	GRUPE SEB France Service Consommateur Tefal 112 Ch. Moulin Carron, TSA 92002 69134 ECULLY Cedex
<b>DEUTSCHLAND GERMANY</b>	0212 387 400	2 Jahre 2 years	GRUPE SEB DEUTSCHLAND GmbH Theodor-Stern-Kai 1 60596 Frankfurt
<b>ELLADA GREECE</b>	2106371251	2 χρόνια 2 years	SEB GROUPE ΕΛΛΑΔΟΣ Α.Ε. Καβαλιεράτου 7 T.K. 145 64 Κ. Κηφισιά
<b>香港 HONG KONG</b>	8130 8998	1 year	SEB ASIA Ltd. 9/F, South Block, Skyway House 3 Sham Mong Road, Tai Kok Tsui, Kowloon Hong-Kong
<b>MAGYARORSZÁG HUNGARY</b>	06 1 801 8434	2 év 2 years	GRUPE SEB CENTRAL-EUROPE Kft. 2040 Budaörs, Puskás Tivadar út 14
<b>INDONESIA</b>	+62 21 5793 7007	1 year	GRUPE SEB INDONESIA (Representative office) Sudirman Plaza, Plaza Marein 8th Floor JL Jendral Sudirman Kav 76-78, Jakarta 12910, Indonesia
<b>ITALIA ITALY</b>	1 99 207 354	2 anni 2 years	GRUPE SEB ITALIA S.p.A. Via Montefeltro, 4 20156 Milano
<b>日本 JAPAN</b>	0570-077772	1年 1 year	株式会社グループセブジャパン 〒144-0042 東京都大田区羽田旭町11-1 羽田クロノゲート事務棟5F
<b>الأردن JORDAN</b>	5665505	1 year	www.tefal-me.com



			
<b>ҚАЗАҚСТАН KAZAKHSTAN</b>	727 378 39 39	2 жыл 2 years	ЖАҚ "ГРУППА СЕБ-ВОСТОК", Мәскеу, 125171, Ленинград тас жолы, 16А үй, 3- құрылыс, XII-ғимарат
<b>한국어 KOREA</b>	080-733-7878	1 year	(유)그룹 세브 코리아 서울특별시 종로구 종로1길 50, 더케이트윈타워 B동 14층 03142
<b>الكويت KUWAIT</b>	1807777 Ext :2104	1 year	www.tefal-me.com
<b>LATVJA LATVIA</b>	6 616 3403	2 gadi 2 years	Groupe SEB Polska Sp. z o.o. Gdański Business Center II D ul. Inflancka 4C 00-189 Warsaw
<b>لبنان LEBANON</b>	4414727	1 year	www.tefal-me.com
<b>LIETUVA LITHUANIA</b>	5 214 0057	2 metai 2 years	Groupe SEB Polska Sp. z o.o. Gdański Business Center II D ul. Inflancka 4C 00-189 Warsaw
<b>LUXEMBOURG</b>	0032 70 23 31 59	2 ans 2 years	GRUPE SEB BELGIUM SA NV 25 avenue de l'Espérance - ZI 6220 Fleurus
<b>МАКЕДОНИЈА MACEDONIA</b>	(02) 20 50 319	2 години 2 years	Груп Себ България ЕООД бул. България 58 С, ет 9, офис 30 1680 София
<b>MALAYSIA</b>	603 7802 3000	2 years	GRUPE SEB MALAYSIA SDN. BHD Unit No. 402-403, Level 4, Uptown 2, No. 2, Jalan SS21/37, Damansara Uptown, 47400, Petaling Jaya, Selangor D.E Malaysia
<b>MEXICO</b>	(55) 52839354	1 año 1 year	Groupe Seb México S.A. de C.V. Calle Boulevard Miguel de Cervantes, Saavedra No 169 Piso 9, Col Ampliación Granada, C.P. 11520, Ciudad de México
<b>MOLDOVA</b>	22 224035	2 роки 2 years	ТОВ «Груп СЕБ Україна» 02121, Харківське шосе, 201-203, 3 поверх, Київ, Україна
<b>NEDERLAND The Netherlands</b>	0318 58 24 24	2 jaar 2 years	GRUPE SEB NEDERLAND B.V. De Schutterij 27 3905 PK Veenendaal
<b>سلطنة عُمان OMAN</b>	24703471	1 year	www.tefal-me.com
<b>POLSKA POLAND</b>	801 300 420 koszt jak za połączenie lokalne	2 lata 2 years	Groupe SEB Polska Sp. z o.o. Gdański Business Center II D ul. Inflancka 4C 00-189 Warsaw

			
<b>PORTUGAL</b>	808 284 735	2 anos 2 years	GRUPE SEB IBÉRICA SA Urb. da Matinha Rua Projectada à Rua 3 Bloco1 - 3° B/D 1950 - 327 Lisboa
قطر <b>QATAR</b>	44485555	1 year	www.tefal-me.com
<b>REPUBLIC OF IRELAND</b>	01 677 4003	2 years	GRUPE SEB IRELAND Unit B3 Aerodrome Business Park, College Road, Rathcoole, Co. Dublin
<b>ROMANIA</b>	0 21 316 87 84	2 ani 2 years	GRUPE SEB ROMÂNIA Str. Ernil Pangratti nr. 13 011881 București
<b>РОССИЯ RUSSIA</b>	495 213 32 30	2 года 2 years	ЗАО «Группа СЕБ-Восток», Москва, 125171, Ленинградское шоссе, д.16А, строение 3, помещение XII
المملكة العربية السعودية <b>SAUDI ARABIA</b>	920023701	2 years	www.tefal-me.com
<b>SRBIJA SERBIA</b>	060 0 732 000	2 godine 2 years	SEB Developpement Đorđa Stanojevića 11b 11070 Novi Beograd
<b>SINGAPORE</b>	6550 8900	2 years	GRUPE SEB (Singapore) Pte. Ltd. 3A International Business Park #12-04/05, ICON@IBP Singapore 609935
<b>SLOVENSKO SLOVAKIA</b>	232 199 930	2 roky 2 years	GRUPE SEB Slovensko, spol. s r.o. Cesta na Senec 2/A 821 04 Bratislava
<b>SLOVENIJA SLOVENIA</b>	02 234 94 90	2 leti 2 years	GRUPE SEB Slovensko, spol. s r.o. Cesta na Senec 2/A 821 04 Bratislava
<b>ESPAÑA SPAIN</b>	933 06 37 65	2 años 2 years	GRUPE SEB IBÉRICA S.A. C/ Almogàvers, 119-123, Complejo Ecourban 08018 Barcelona
<b>SVERIGE SWEDEN</b>	08 629 25 00	2 år 2 years	TEFAL - OBH Nordica Group AB Löfströms Allé 5 172 66 Sundbyberg
<b>SUISSE SCHWEIZ SWITZERLAND</b>	044 837 18 40	2 ans 2 Jahre 2 years	GRUPE SEB SCHWEIZ GmbH Thurgauerstrasse 105 8152 Glattpark
ประเทศไทย <b>THAILAND</b>	02 765 6565	2 years	GRUPE SEB THAILAND 2034/66 Italthai Tower, 14th Floor, n° 14-02, New Phetchburi Road, Bangkapi, Huaykwang, Bangkok, 10320
<b>TÜRKIYE TURKEY</b>	444 40 50	2 YIL 2 years	GRUPE SEB ISTANBUL AS Dereboyu Cd. Bilim Sk. Sun Plaza No:5 K:2 Maslak 34398 Istanbul
الإمارات العربية المتحدة <b>UAE</b>	8002272	1 year	www.tefal-me.com

			
<b>Україна UKRAINE</b>	044 300 13 04	2 роки 2 years	ТОВ «Груп СЕБ Україна» 02121, Харківське шосе, 201-203, 3 поверх, Київ, Україна
<b>UNITED KINGDOM</b>	0345 602 1454	2 years	GRUPE SEB UK LTD Riverside House, Riverside Walk Windsor, Berkshire, SL4 1NA
<b>U.S.A.</b>	800-395-8325	1 year	GRUPE SEB USA 2121 Eden Road Millville, NJ 08332
<b>VIETNAM</b>	1800-555521	2 năm 2 years	Vietnam Fan Joint Stock Company 25 Nguyen Thi Nho Str, Ward 9, Tan Binh Dist, HCM city

24/10/2018

### INTERNATIONAL GUARANTEE

**Date of purchase** / Date d'achat / Fecha de compra / Købsdato / Ostopäivä / Kjøpsdato / Inköpsdatum / Ostukuupäev / Pirkuma datums / Įsigijimo data / Data zakupu / Datum izročitve blaga / Datum kupovine / Vásárlás dátuma / Data achiziției / Дата на закупуване / Дата продажу / Чудовищн ор. / Дата продажи / Сатылган күні / 購入日 / วันที่ซื้อ / 구입일자 / Датум на купување :

**Product reference** / Référence produit / Referencia del producto / Referencenummer / Tuotenumero / Artikelnummer / Produktreferens / Toote viitenumber / Produkta atsauces numurs / Gaminio numeris / Referenca produktu / Oznaka proizvoda / Tip aparata / Készülék típusa / Cod produs / Модел / Модель / Униќа. / Модель / Үлгісі / 製品リファレンス番号 / รุ่นผลิตภัณฑ์ / 제품명 / Податоци за производот:

**Retailer name and address** / Nom et adresse du revendeur / Nombre y dirección del minorista / Forhandler navn & adresse / Jälleenmyyjän nimi ja osoite / Forhandler navn og adresse / Återförsäljarens namn och adress / Müüja kauplus ja aadress / Veikala nosaukums un adrese / Parduojuvės pavadinimas ir adresas / Nazwa i adres sprzedawcy / Naziv i adresa prodajnog mjesta / Naziv in naslov trgovine / Forgalmazó neve és címe / Numele și adresa vânzătorului / Търговки обект / Назва та адреса продавця / Чудовищн ор. и хуугт. / Название и адрес продавца / Сатушының атауы мен мекен-жайы / 販売店名、住所 / ชื่อและที่อยู่ของห้าง/ร้านที่ซื้อ / 소매점 이름과 주소 / Име и адреса на продавач :

**Distributor stamp** / Cachet / Sello del distribuidor / Forhandler stempel / Jälleenmyyjän leima / Forhandler stempel / Återförsäljarens stämpel / Tempel / Žīmogs / Antspaudas / Pieczęć sprzedawcy / Pečat distributera / Pečat trgovine / Forgalmazó pecsétje / Ștampila vânzătorului / Печат на търговския обект / Печатка продавця / Чудовищн ор. / Печать продавца / Сатушының мөрі / 販売店印 / ตราประทับของห้าง/ร้านที่ซื้อ / 소매점 직인 / Печат на дистрибутор :

