



CREATOR™



31136



3 in 1
3 en 1
3 em 1
3合1

3 w 1
3 v 1
3 az 1-ben
3 in 1

„3 в 1“
Kolm ühes
3 viename



LEGO.com/sustainable-packaging



BUILDER



Apple and the Apple logo are trademarks of Apple Inc., registered in the U.S. and other countries and regions. App Store is a service mark of Apple Inc. Google Play and the Google Play logo are trademarks of Google LLC. Tencent and the Tencent logo are trademarks of Tencent Inc.

[LEGO.com/devicecheck](https://www.lego.com/devicecheck)

EN Ask parents' permission before going online | **DE** Eltern um Erlaubnis bitten, bevor du online gehst | **FR** Demande l'autorisation d'un parent avant d'aller en ligne | **IT** Chiedi il permesso ai tuoi genitori prima di andare online | **ES** Pídeles permiso a tus papás antes de conectarte a Internet | **PT** Pede autorização aos pais antes de acederes online | **JA** オンラインになる前に ほか者の方のきよかをもらおう | **ZH** 上网前应先征得父母的同意 | **KO** 온라인 접속 전에 보호자 동의가 필요합니다 | **RU** Спроси разрешения у родителей, прежде чем заходить в интернет | **PL** Poproś rodziców o zgodę, zanim wejdziesz do Internetu | **CS** Než půjdeš na internet, požádej rodiče o svolení | **SK** Skôr než pôjdeš na internet, vypýtaj si povolenie od rodičov | **HU** Kérj szülői engedélyt, mielőtt online csatlakoznál! | **RO** Cere permisiunea părinților înainte de a te conecta online | **BG** Поискайте разрешение от родител, преди да влезете онлайн | **LV** Pirms došanās tiešsaistē palūdz atļauju vecākiem | **ET** Enne Interneti kasutamist küsi vanematelt luba | **LT** Prieš prisijungdami prie interneto, atsklauskite tėvų

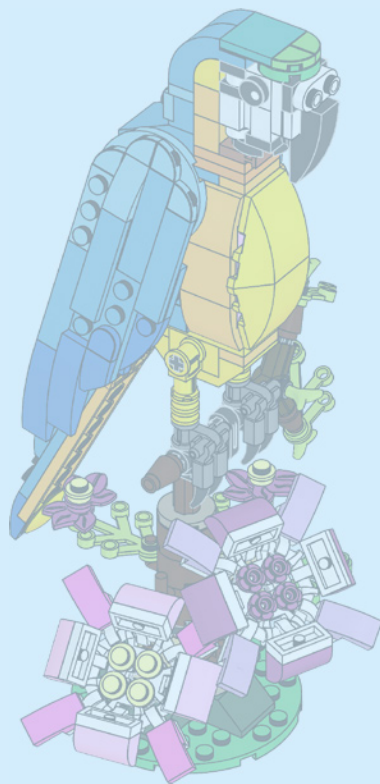

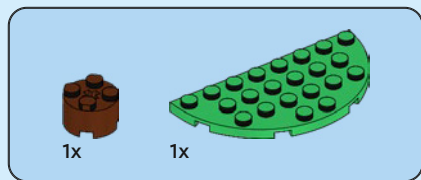

1

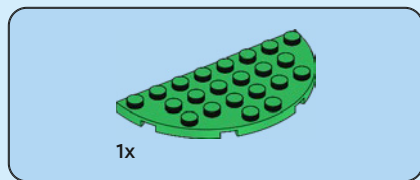
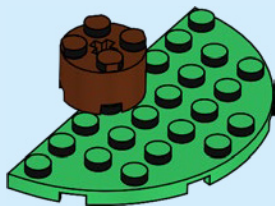

2

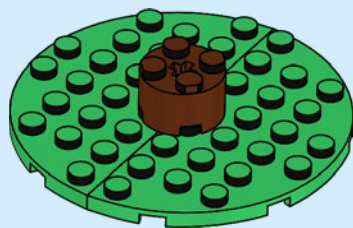



4x

3

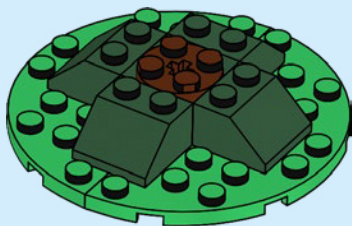

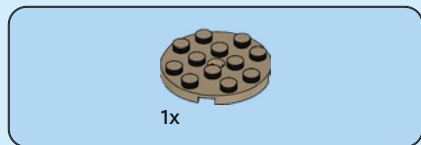

4

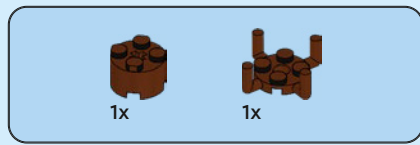
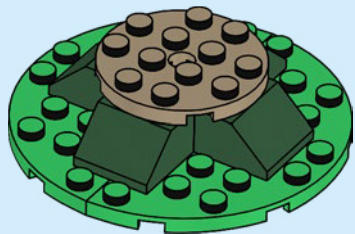

5

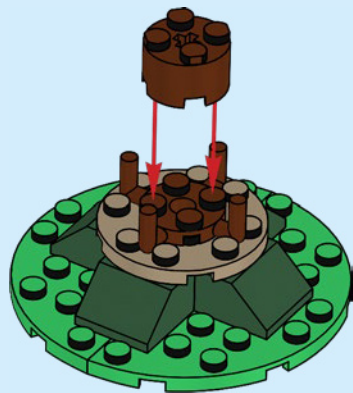

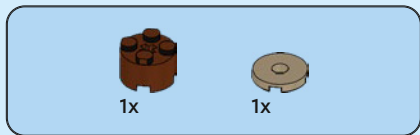
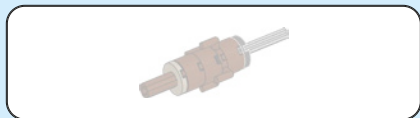

6

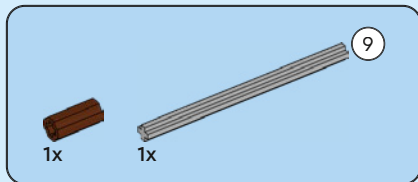
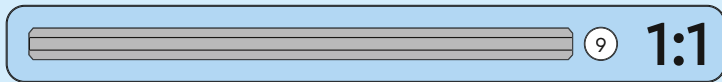
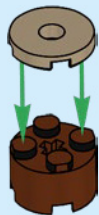

7

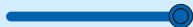
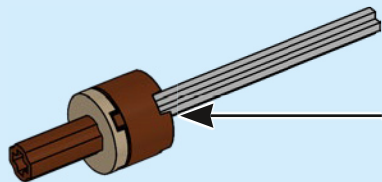
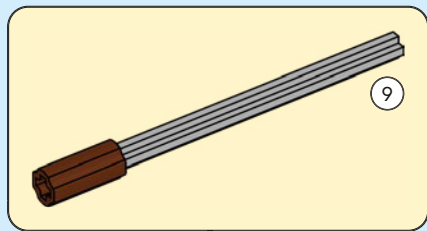



1x



1x

8

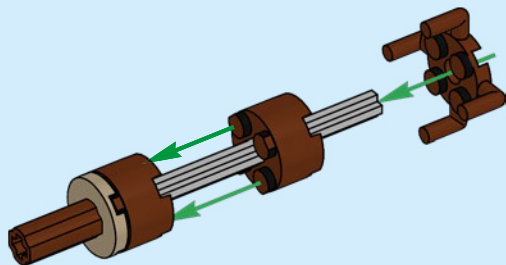

1x



1x

9

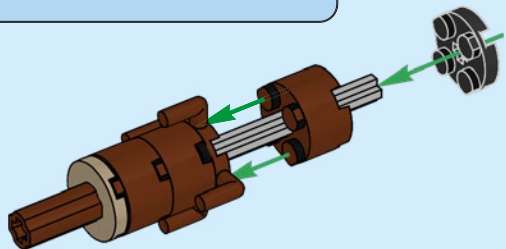

10

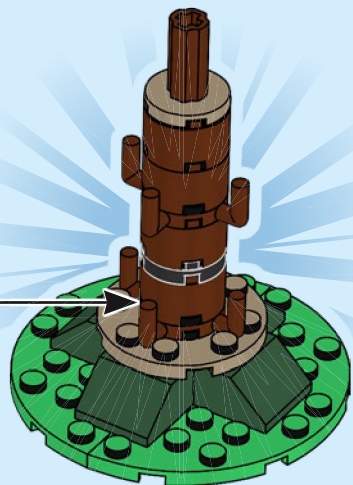

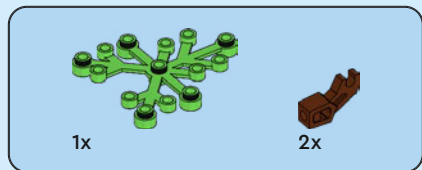

11

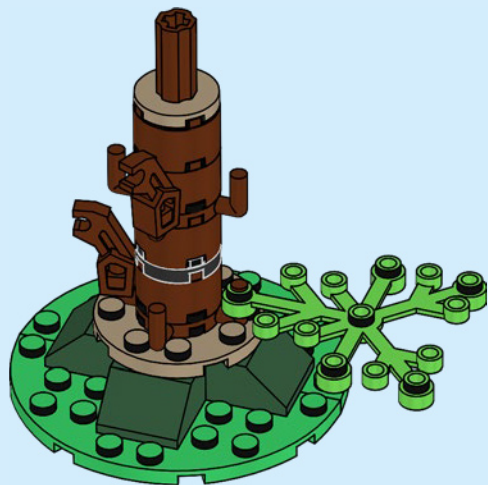



1x

12



4x

13





14

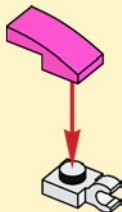

4x

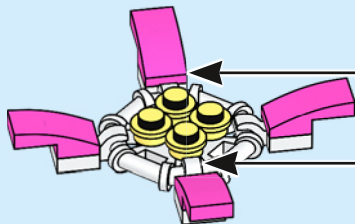

15

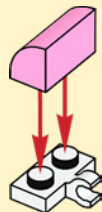

4x

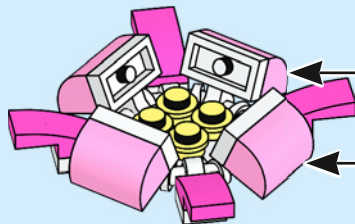

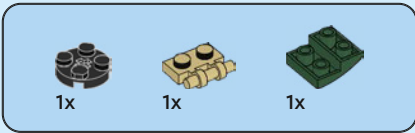

16

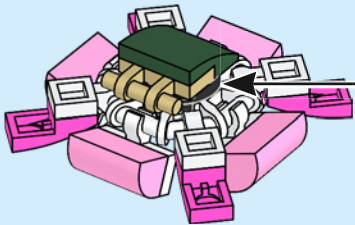

17

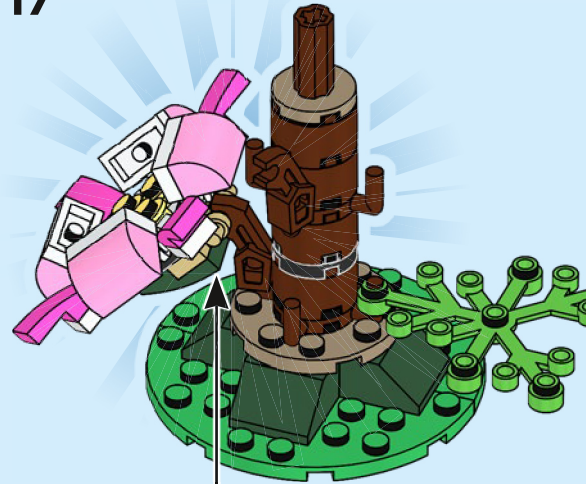



1x



18



4x

19

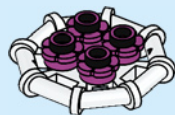



20

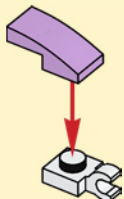

4x

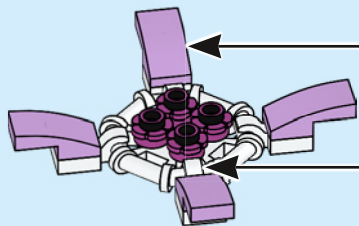

21

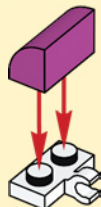

4x



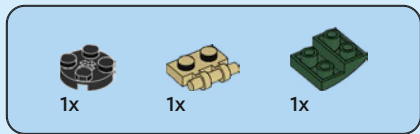

22

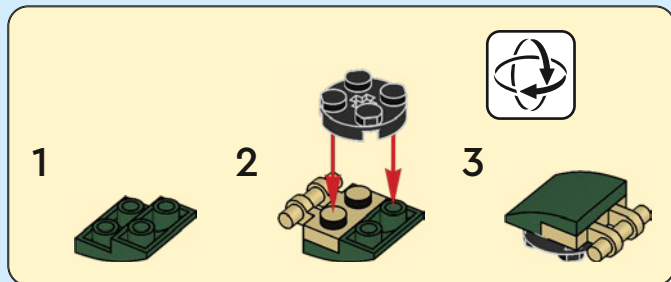

23

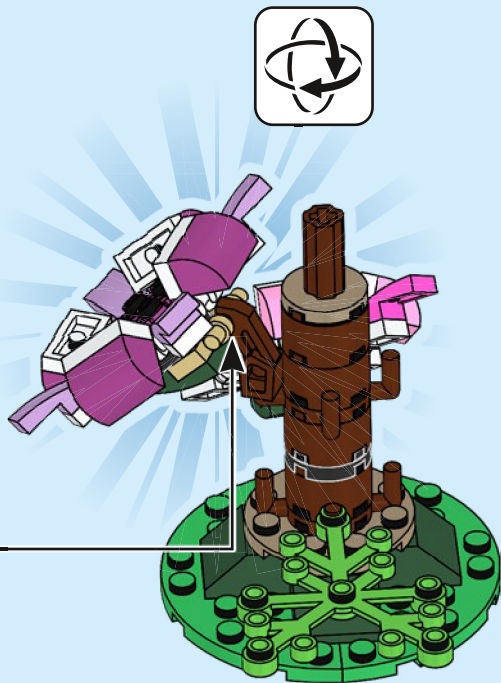



24

1



2

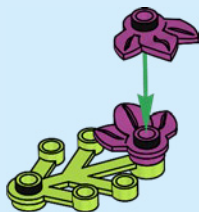

3



2x



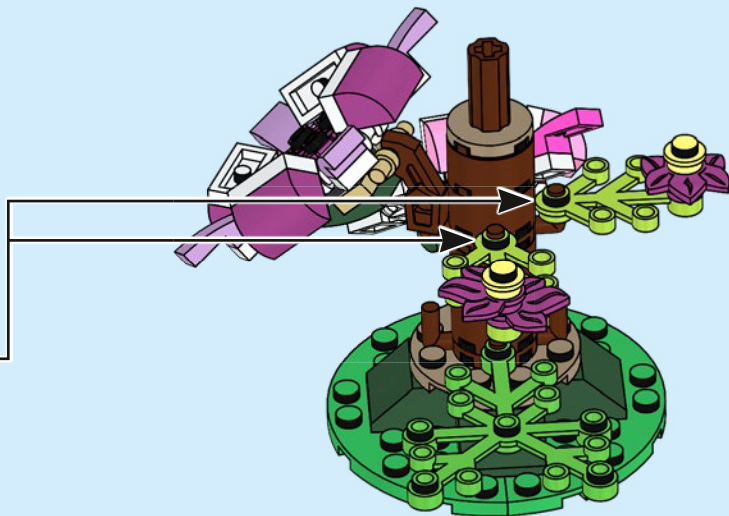



1x



1x

25

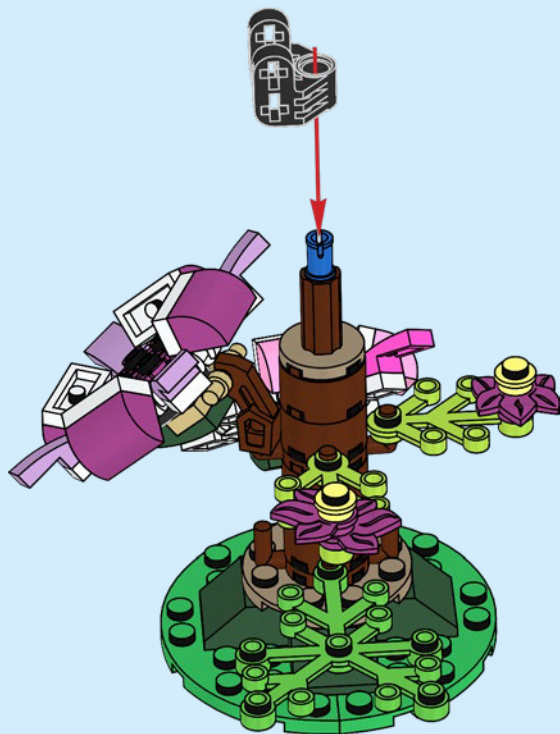



2x

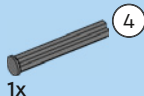

1x



1x

26



4

1:1



1x

27

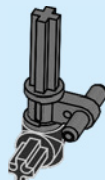



2x

28

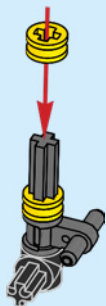

2x

29

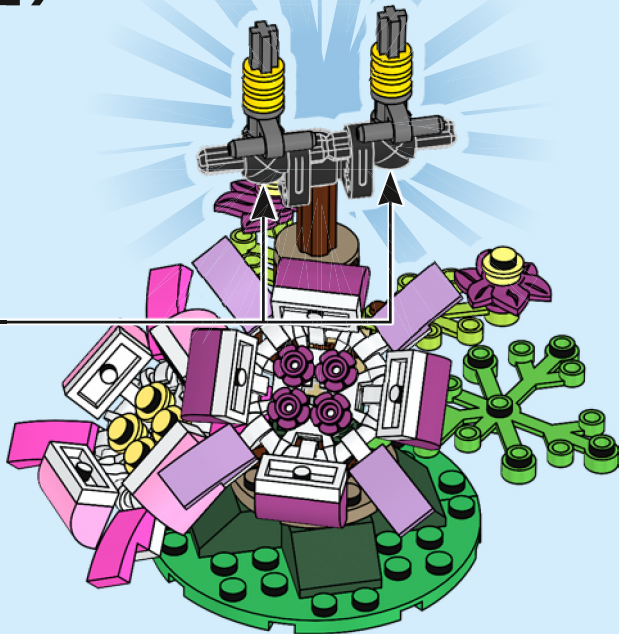



30

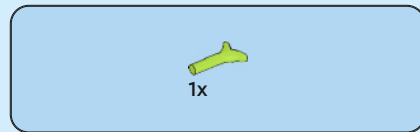
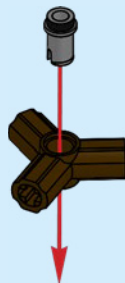

31

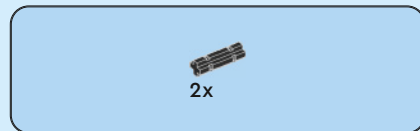

32

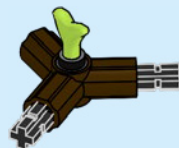



2x

33



2x

34

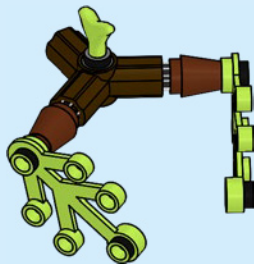



2x

35

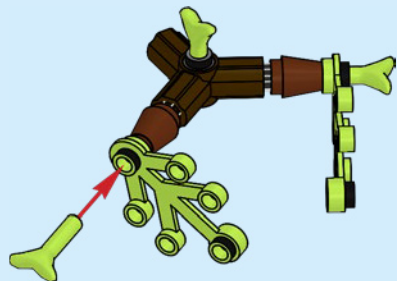

36

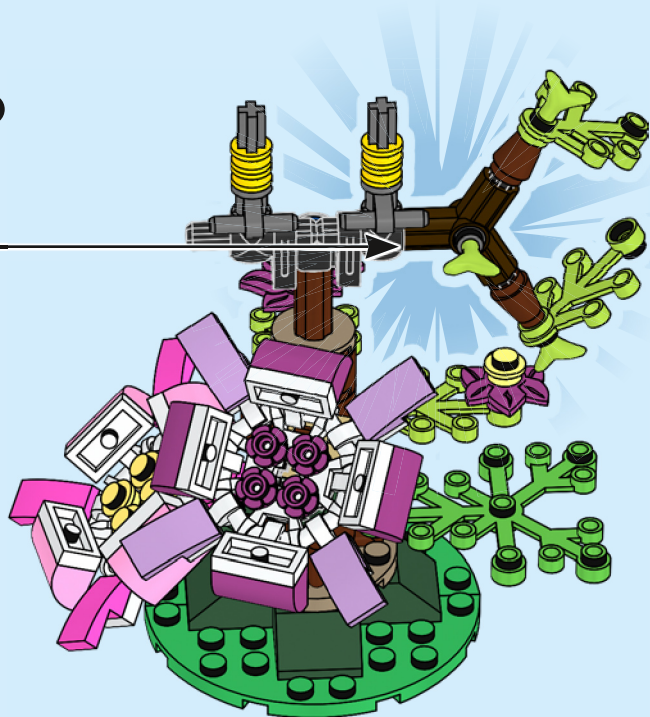



4x



4x

37



4x



4x

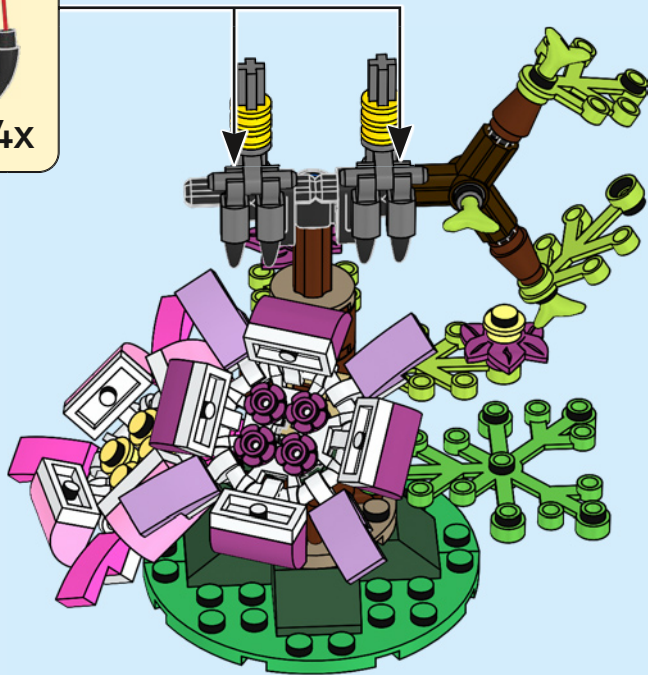



1x

38

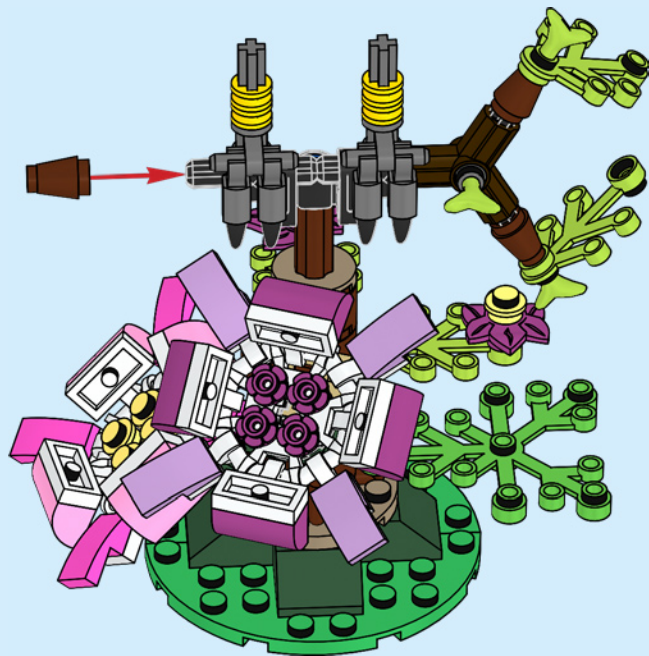

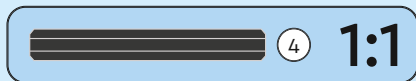
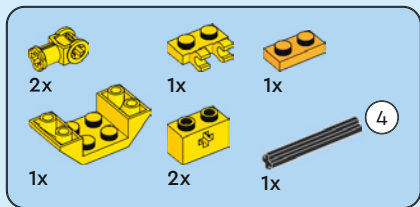

39

1

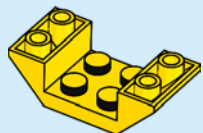

2



3

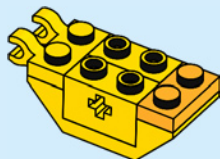

4

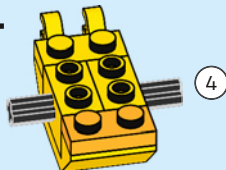

5

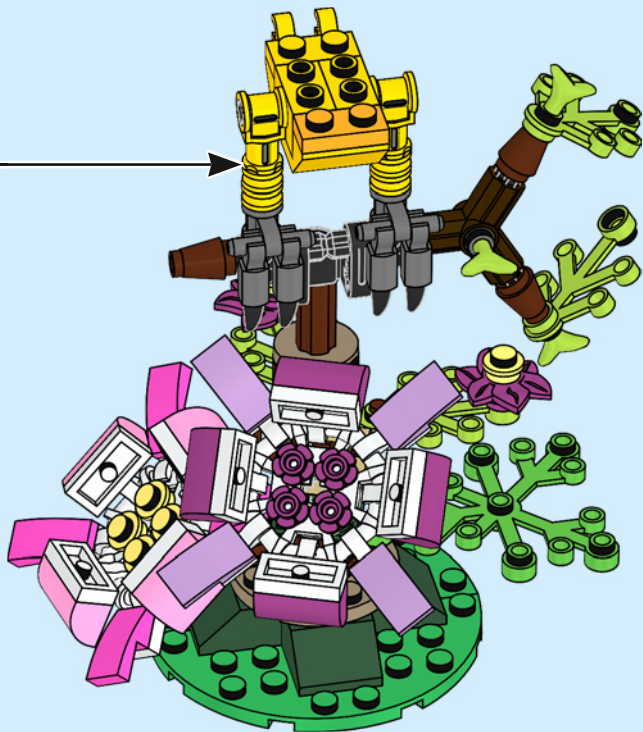
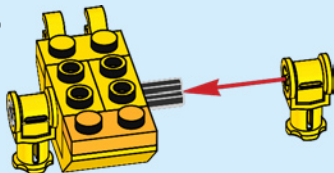

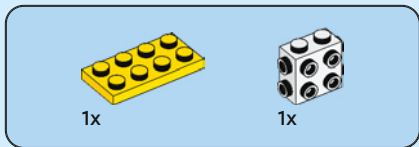
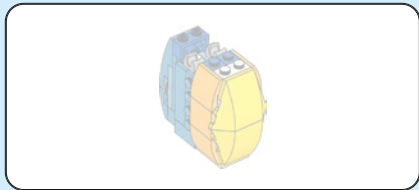

40

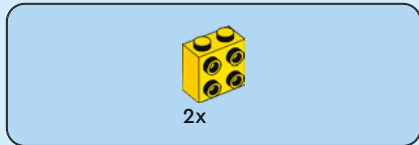
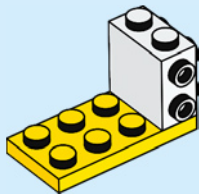

41

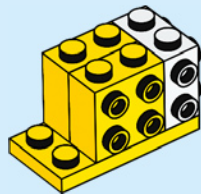



1x

42

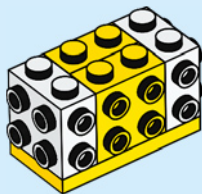

1x



1x

43

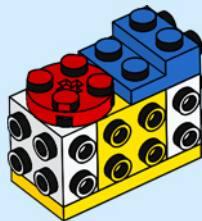



1x



1x

44

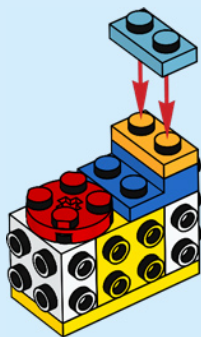

1x



1x

45

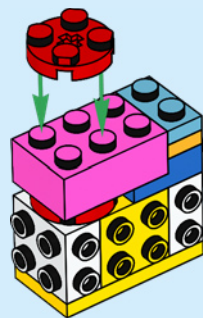

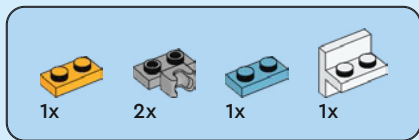

46

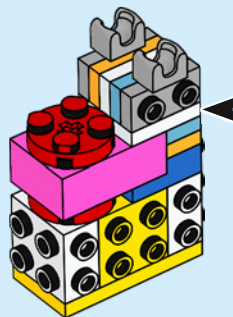
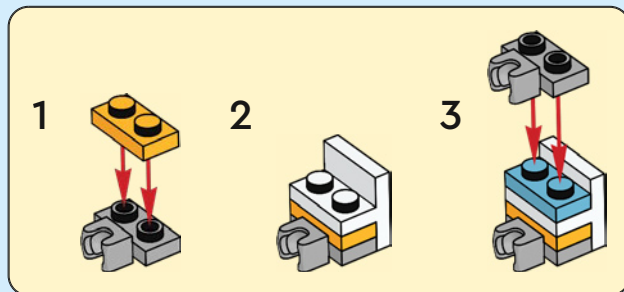

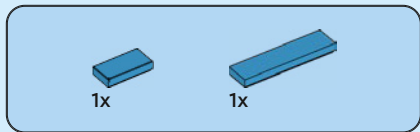

47

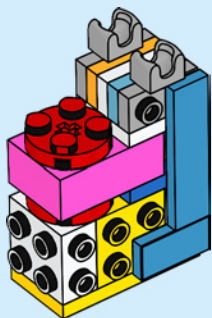

48

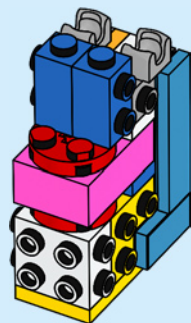



1x

49

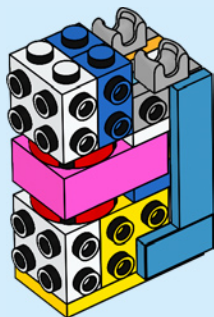

1x



1x

50

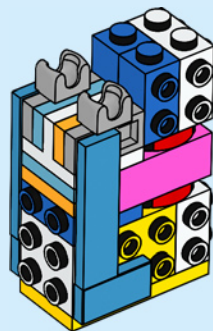



1x

51

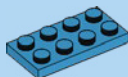
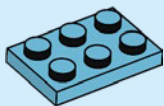

1x

52

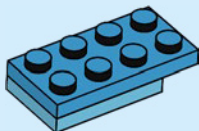

1x

53

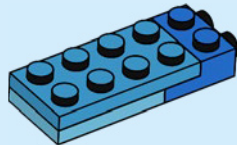



1x

54

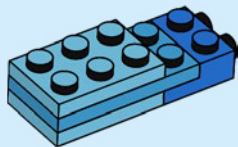

1x



1x

55

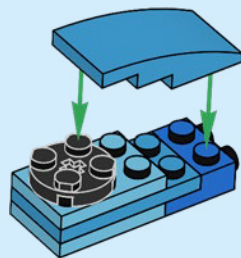

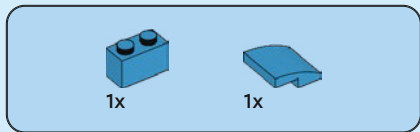

56

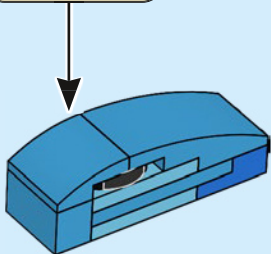
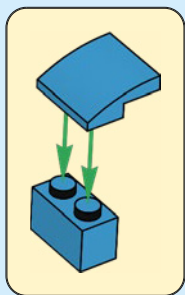

57

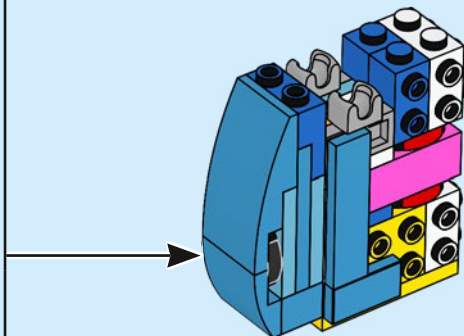

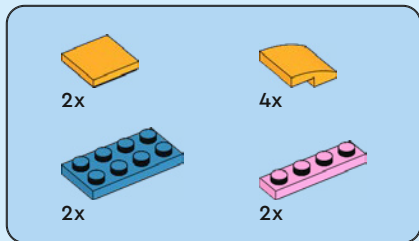

58

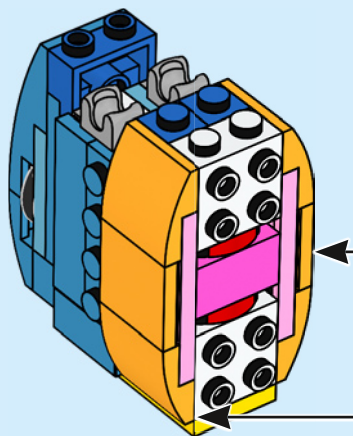
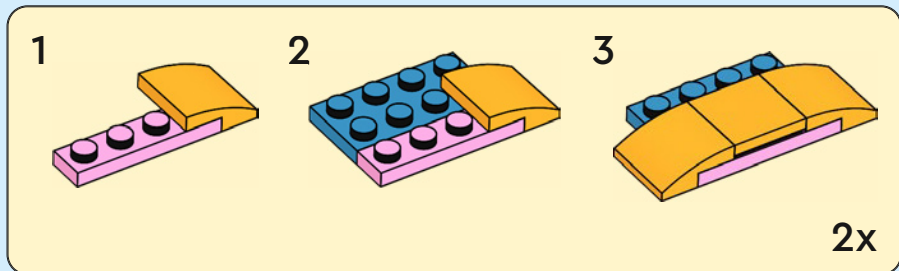

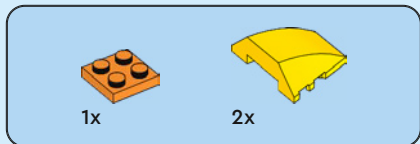

59

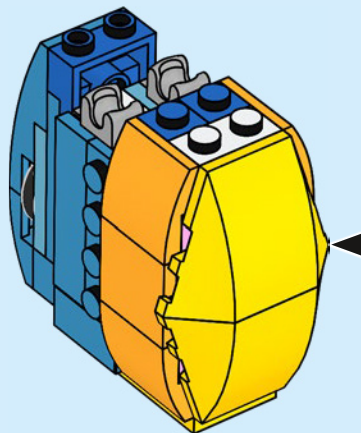
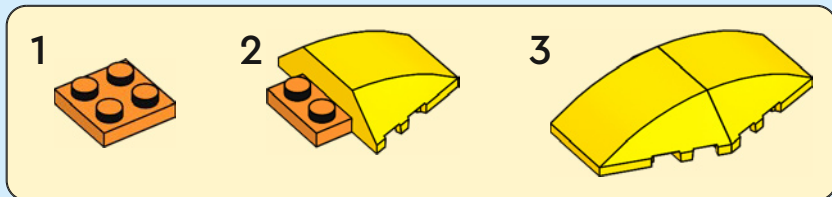

60

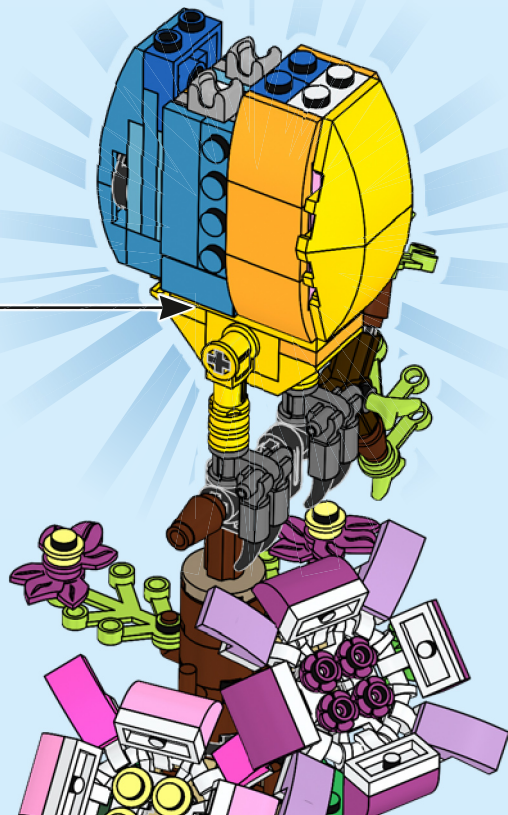

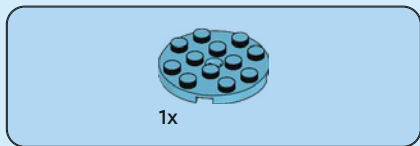
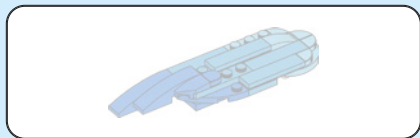

61

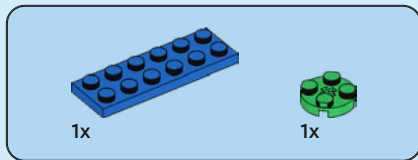

62

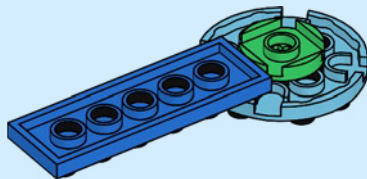

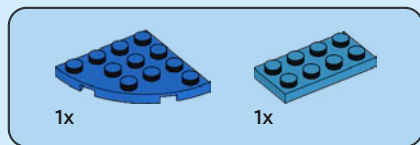

63

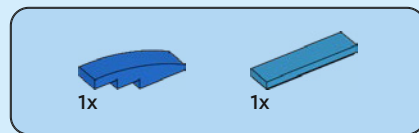
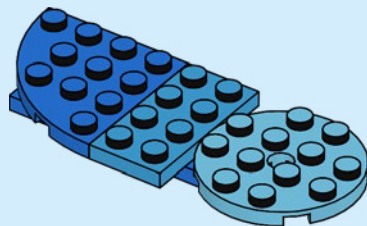

64

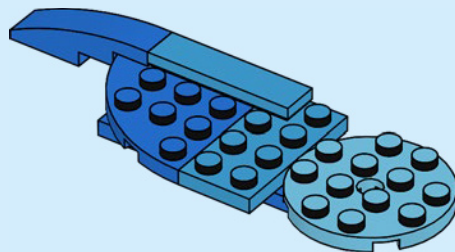

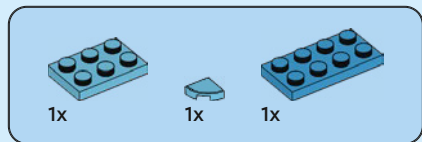

65

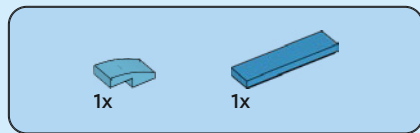
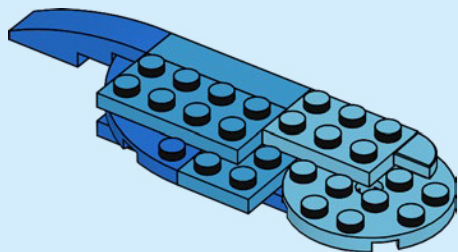

66

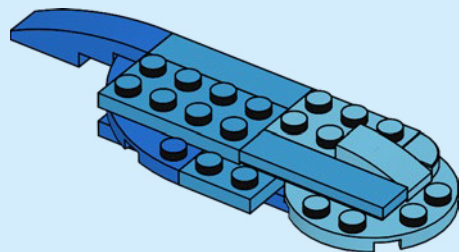



3x

67

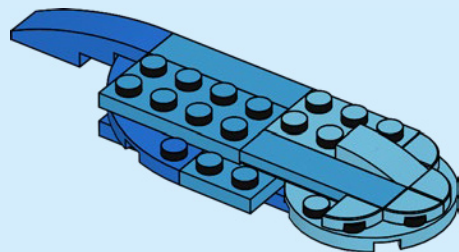

2x

68

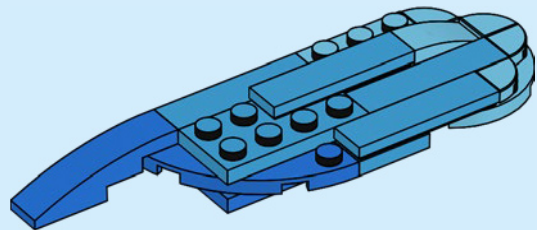

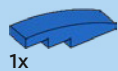

1x

69

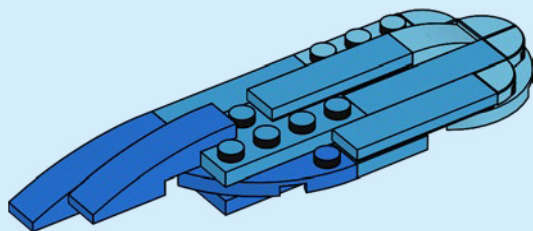

1x



1x

70

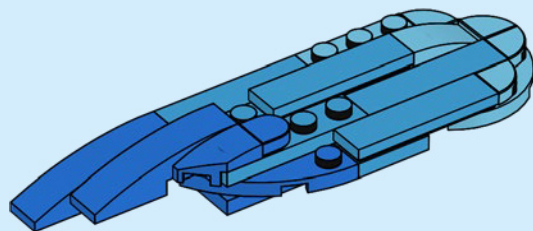



1x

71

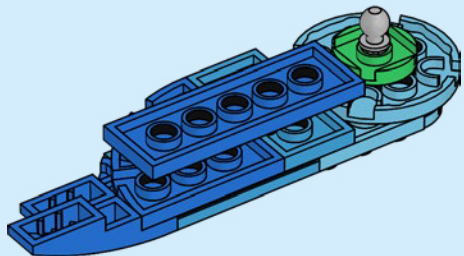

72

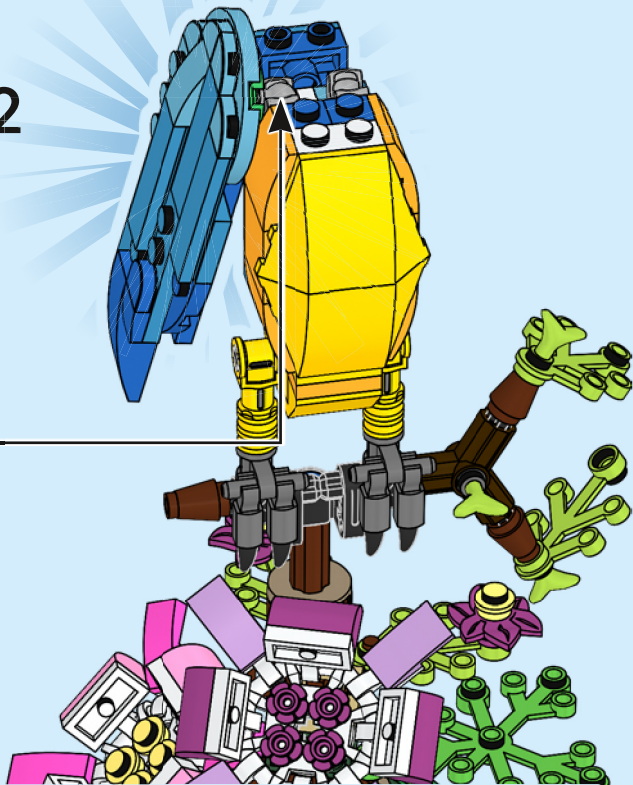

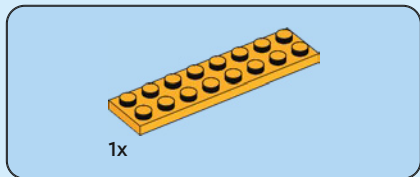
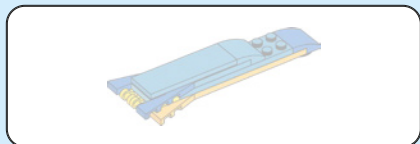

73

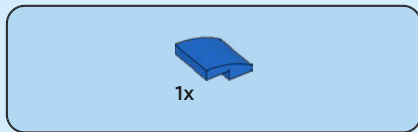
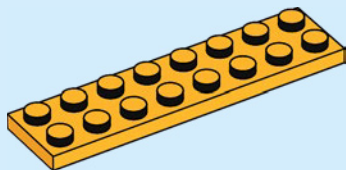

74

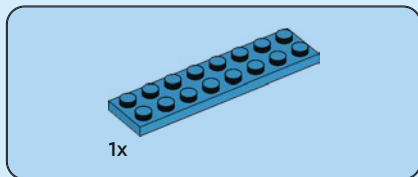
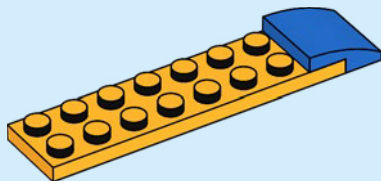

75

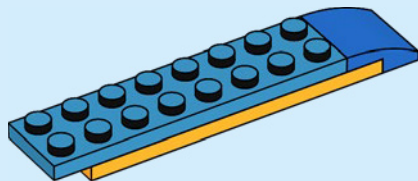



1x



1x

76

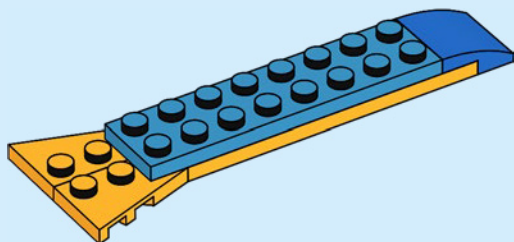

2x

77

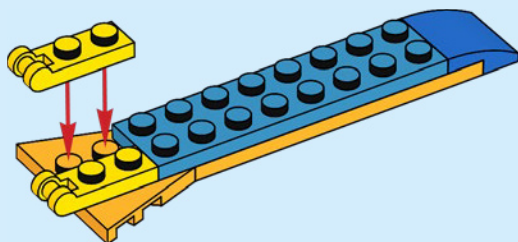

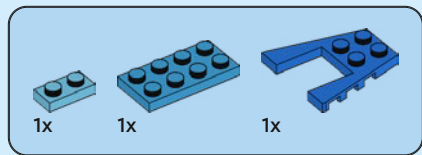

78

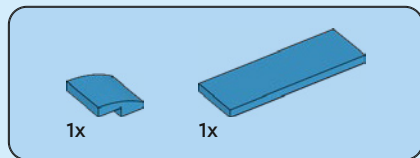
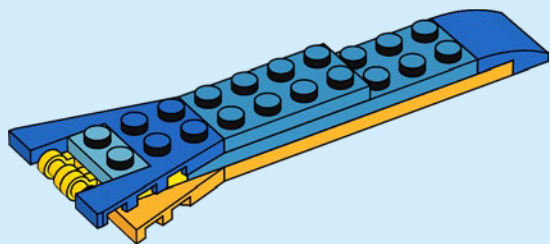

79

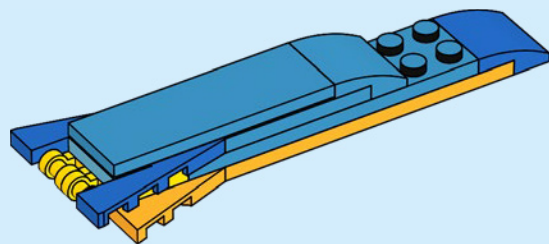



1x

80

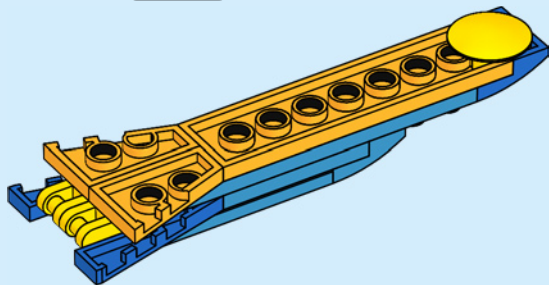

81

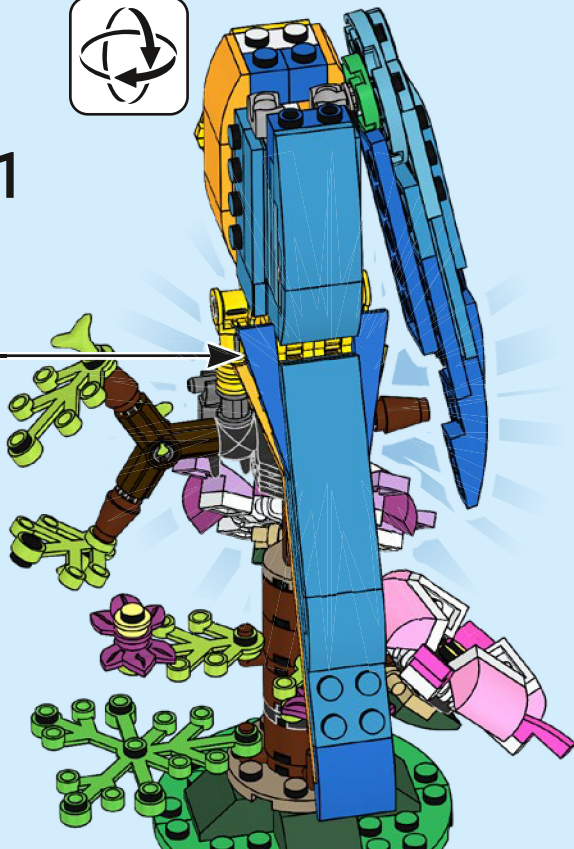

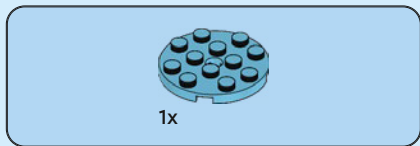
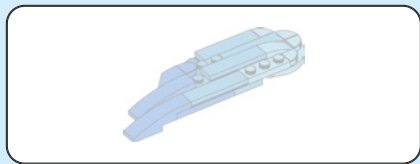

82

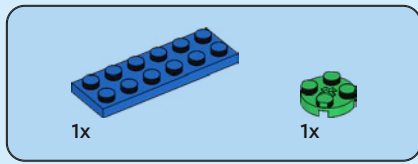
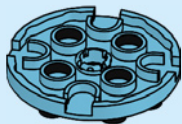

83

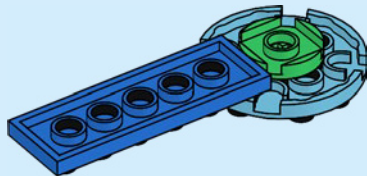

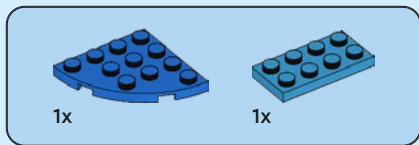

84

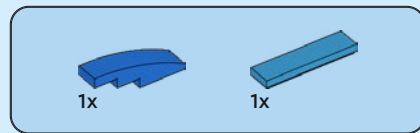
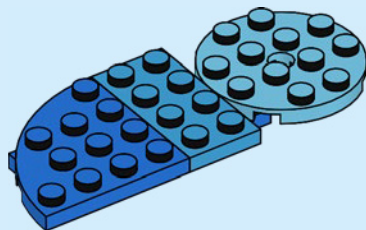

85

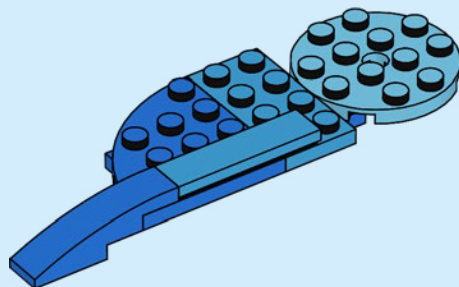

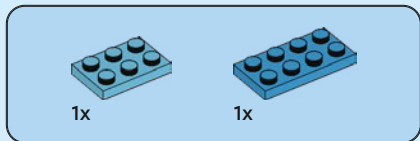

86

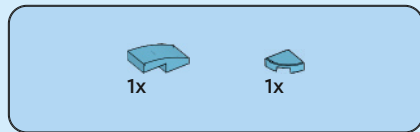
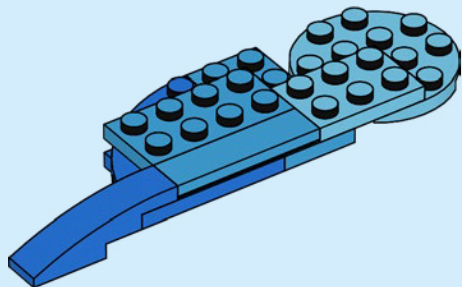

87

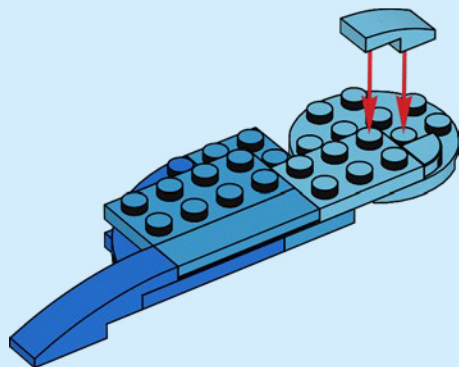



2x

88

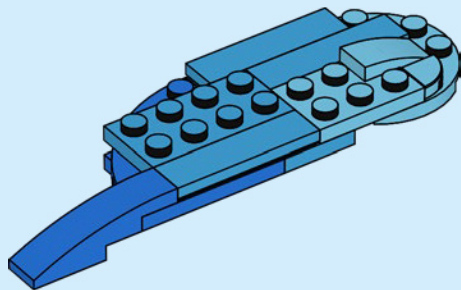

3x

89

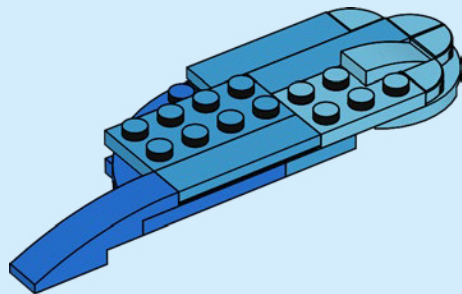



1x



1x

90

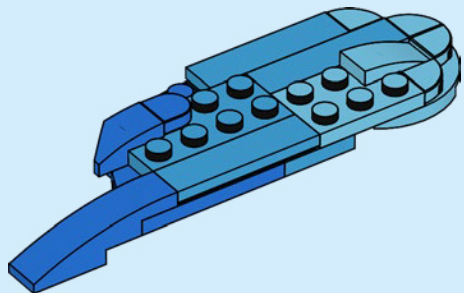

1x



1x

91

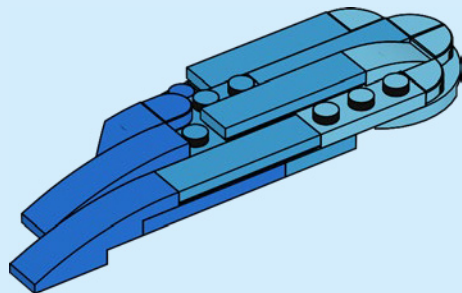



92

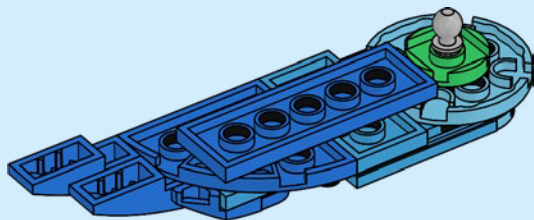

93

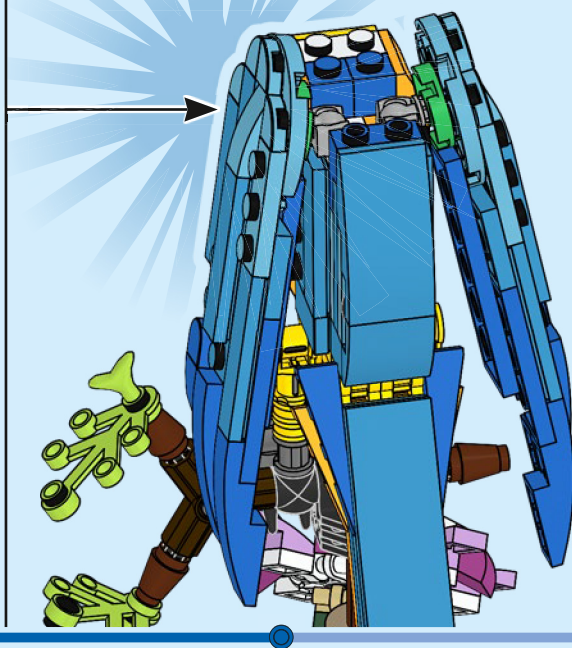

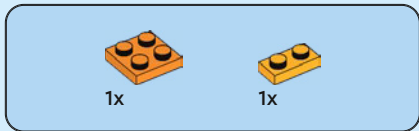
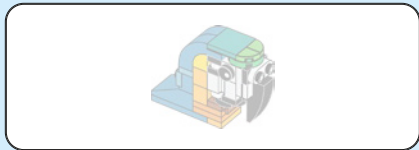

94

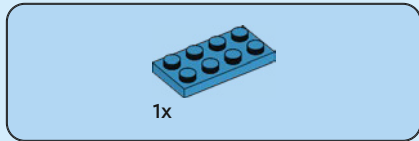
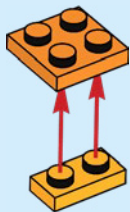

95

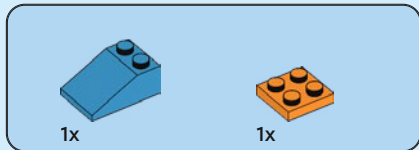
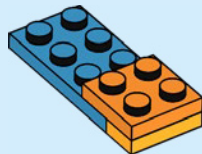

96

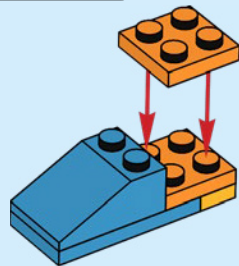



2x

97

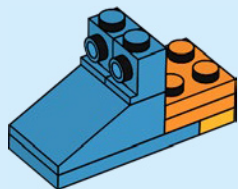

1x

98

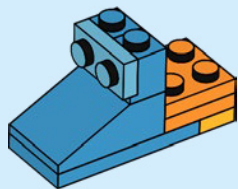

1x



1x

99

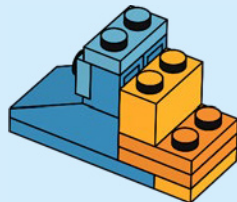

1x



1x

100

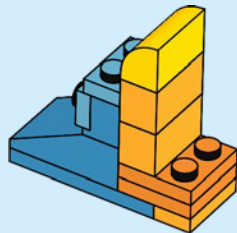

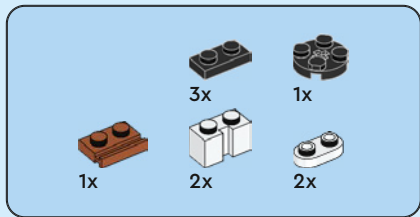

101

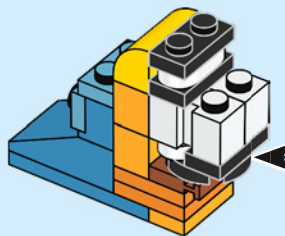
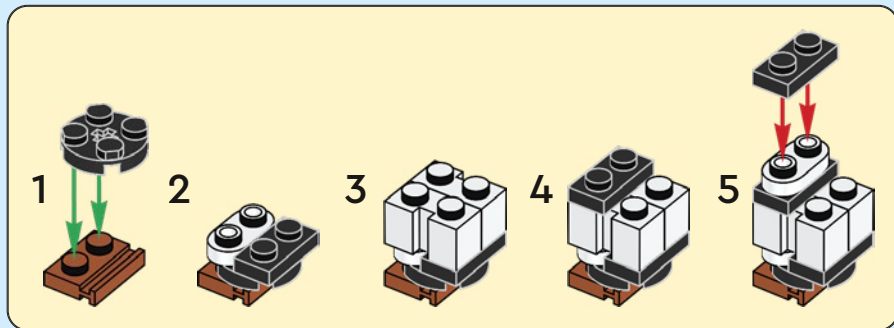



2x

102

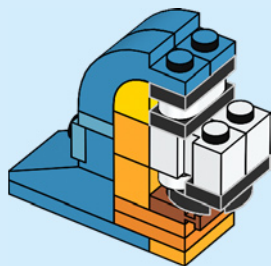

2x

103

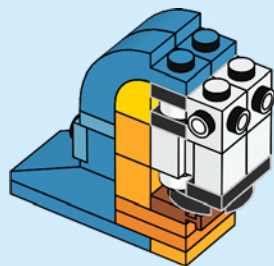



104

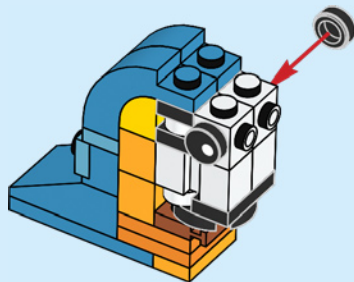

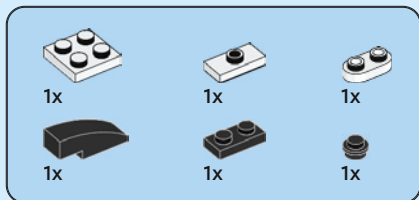

105

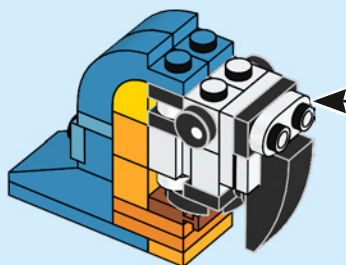
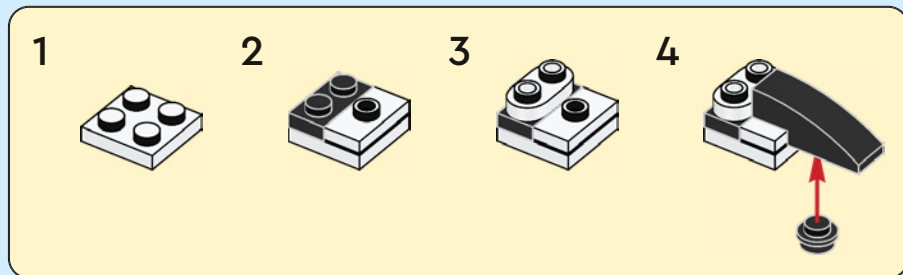



1x



1x

106

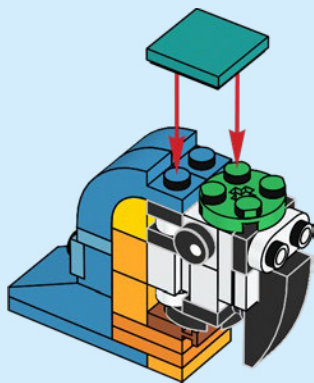

2x

107

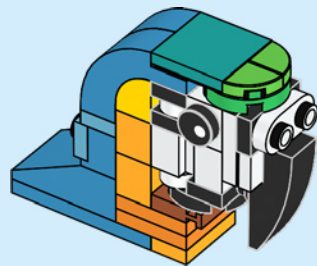

108

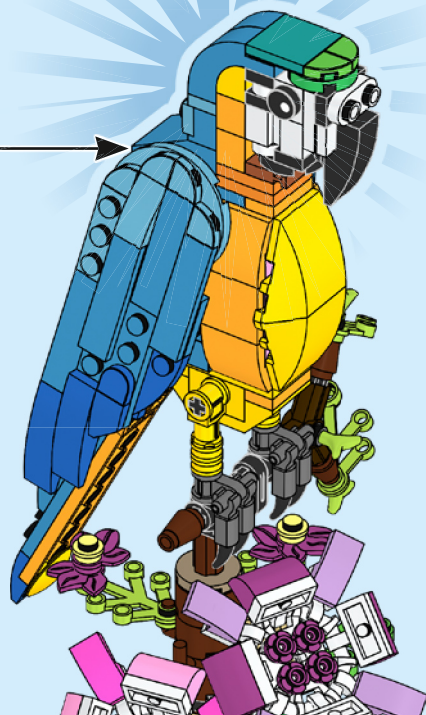

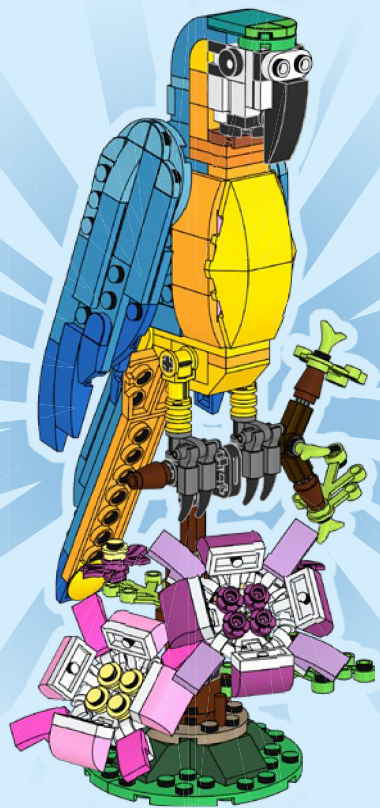



CREATOR™

3 IN 1

31137



31139



31138



31136

31135



31134



31140



YOU COULD **WIN**



Scan this QR code or go to **LEGO.COM/PRODUCTFEEDBACK** and give us your short feedback about this LEGO® set for a chance to win a cool LEGO prize.

Terms and Conditions apply*

DE: Du könntest GEWINNEN. Es gelten die Teilnahmebedingungen* **FR: Tu pourrais GAGNER.** Des conditions s'appliquent* **IT: Potresti VINCERE tu.** Termini e condizioni sono applicabili* **ES: Puedes GANAR.** Aplican términos y condiciones* **PT: Poderá GANHAR.** Aplicam-se termos e condições* **JA: プレゼント付き! 利用規約が適用されます*** **ZH: 轻松获奖. 条款和条件适用*** **KO: 상품의 주인이 되어보세요. 소정의 약관이 적용됩니다*** **RU: Вы можете ВЫИГРАТЬ.** Действуют положения и условия* **PL: Szansa na WYGRANĄ.** Obowiązują warunki korzystania* **CS: Máte šanci VYHRÁT.** Platí všeobecné smluvní podmínky* **SK: Máte šancu VYHRAŤ.** Platia všeobecné zmluvné podmienky* **HU: TE IS NYERHETSZ.** Felhasználási feltételek érvényesek* **RO: Ai putea CÂȘTIGA.** Se aplică termeni și condiții* **BG: Можете да СПЕЧЕЛИТЕ.** Има определени правила и условия* **LV: Tu vari LAIMĒT.** Ir spēkā noteikumi un nosacījumi.* **ET: Sul on võimalus VÕITA.** Kehtivad tingimused* **LT: Jūs galite LAIMĖTI.** Taikomos sąlygos*
*LEGO.com/productfeedback-terms